

PRE-QUALIFICATION STATEMENTS

FACTORY SCENERY



TABLE OF CONTENTS

- 1. Greeting**
- 2. General Information**
- 3. Business of Activity**
- 4. Organization**
- 5. Engineering Program**
- 6. Qualified Technical Licenses of Employee**
- 7. Production Equipment List**
- 8. Inspection & Testing Equipment List**
- 9. Certificate of ISO 9001/14001**
- 10. Major Reference List (Silencer Part)**
- 11. Shop HSE Plan**
- 12. Details of sub-suppliers List**
- 13. Company Quality Management System Manual**
- 14. Catalogs of the Products**



1. GREETING

Dear sirs,

We are pleased to furnish our General Pre-qualification Statements outlining JS TECHNOS's capabilities and qualification for consulting, engineering, designing and manufacturing services at home and abroad.

As a pioneer, we are one of the leading companies in Korea which have produced Noise and Vibration control system, we have done our best to develop quality assurance and control for engineering, design and manufacturing since 2001 established as Noise and Vibration company.

With our technical experience and capability as well as our unflinching spirit of devotion to the clients concerned, we would like to assure you that we will do our utmost to successfully execute any designated project at the most economical price and in the shortest span of time, if and when we are granted an opportunity to serve you.

Should you need any further information for your specific requirements, please feel free to contact us at any time for our immediate compliance.

We sincerely hope that all the information furnished herewith could meet your satisfaction and we look forward to receiving your kind attention and consideration.

Very truly yours,

JS TECHNOS Co., Ltd.



2. GENERAL INFORMATION



3. BUSINESS OF ACTIVITY

3. BUSINESS OF ACTIVITY

A. ENGINEERING PART

1. Noise and vibration control system engineering
 - Steam silencer
 - Air/Gas silencer
 - Fan silencer
 - Acoustic enclosure
 - Acoustic chamber
 - The other Noise and Vibration control system

2. Design and Consultant for Plant noise control
 - Power plant noise control
 - Chemical plant noise control
 - The other plant noise control

3. Pipe stress analysis
 - Pipe stress analysis for High & Low temperature Pipe

B. MANUFACTURING PRODUCT PART

1. Noise control products
 - Steam silencer
 - Air/Gas silencer
 - Fan silencer
 - Acoustical enclosure
 - Acoustic chamber
 - The other noise control products
2. Supplementary steel for Pipe hanger & Support

C. AGENT PART

1. Vibration control products
 - . Spring mount, neoprene mount/pad
 - . Spring hanger, neoprene hanger
 - . flexible connector
 - . Anti-vibration base
 - . Isolated wall/ceiling system

MANUFACTURING CAPACITY

1) HANDLING ITEM SIZE

Max. size <thick(mm) x diameter(m) x length(m) x weight(ton)> in manufacturing

- 30T x Ø4500 x 10000L x 25ton

2) Max. Power (Kw)

- 350

3) Monthly production capacity and work load

- Average production (ton, set / month) : 25 set / month

4) Experienced material in welding and forming (yes or no)

- C/steel : yes - S/steel : yes - Clad steel : no
 - 1 1/4Cr-Mo : yes - 2 1/4Cr-1Mo : yes - 5Cr-1/2Mo : yes
 - Ni steel : yes - Cr steel : yes - Inconel/Incoloy : no

5) Main material & fabrication sourcing

a) Procurement of raw material

	Plate	Forgings	Pipe&Fitting	etc
- On shore :	<u>80 %</u>	<u>2 %</u>	<u>5 %</u>	<u>13 %</u>
- Off shore :	<u>0 %</u>	<u>0 %</u>	<u>0 %</u>	<u>0 %</u>

b) Fabrication

	Forming	Machining	Fabrication	Sand/Paint
- Shop made :	<u>0 %</u>	<u>30 %</u>	<u>90 %</u>	<u>0 %</u>
- On shore :	<u>100 %</u>	<u>70 %</u>	<u>10 %</u>	<u>100 %</u>
- Off shore :	<u>0 %</u>	<u>0 %</u>	<u>0 %</u>	<u>0 %</u>

6) Transportation route

a) Max. equipment size for In-land transport.

- Width(m) x height(m) x length(m) x weight(ton) : 4.5 x 4.5 x 10.0 x 25ton

b) Name of available port / Location(Km) from shop : Busan/400, Masan/350, Incheon/30

7) Engineering

a) Code application for design and fabrication (yes or no, descibe if any)

- ASME Sec. VIII Div. 1 : yes - ASME Sec. VIII Div. 2 : yes
 - ASME Sec. I : yes

CODE STAMP, Third Party Type Test, Approval
1. CODE & STAMP

: Not registered

2. Third Party Type Test

Description	Approval ID No	Iteam	Project Name	EPC	LOCATION
ARAMCO	WRCI-Q74-01-A058-DA	Silencer	Luberef Yanbu Refinery Expansion Project	SECL	YANBU, SAUDI ARBIA
			Wasit #2 Cogeneration & Steam Generation Project	SECL	AL JUBAIL, SAUDI ARBIA
			Shaybah #2, #4 Recovery & Utilities Project	SECL	AL JUBAIL, SAUDI ARBIA
			Jubail Export Refinery Project Pkg #3 Aromatics Units	SECL	AL JUBAIL, SAUDI ARBIA
SEC	-		Shoaiba II Combined Cycle Power Plant	DAELIM	SHOAIBA, SAUDI ARBIA
SASO	-		N/A		

Third Party	SGS Korea Co., Ltd.	SECL / Wasit #2 Cogeneration & Steam Generation Project DAELIM / Shoaiba II Combined Cycle Power Plant
	KICO Inc.	SECL / Shaybah #2, #4 Recovery & Utilities Project
	A&A Eng Co., Ltd.	SECL / Shaybah #2, #4 Recovery & Utilities Project
	EGS Corp.	SECL / Jubail Export Refinery Project Final Inspection.
Remarks	* SECL : SAMSUNG ENGINEERING CO., LTD. DAELIM : DAELIM INDUSTRIAL CO., LTD. DESCRIPTION OF INSPECTION/TEST 1. FINAL INSPECTION - MATERIAL IDENTIFICATION(MILL CERTIFICATION REVIEW) - VISUAL & DIMENSION - PERFORMANCE TEST (AT SHOP) - PAINTING 2. PACKING	

MAIN PRODUCTION PROCESS

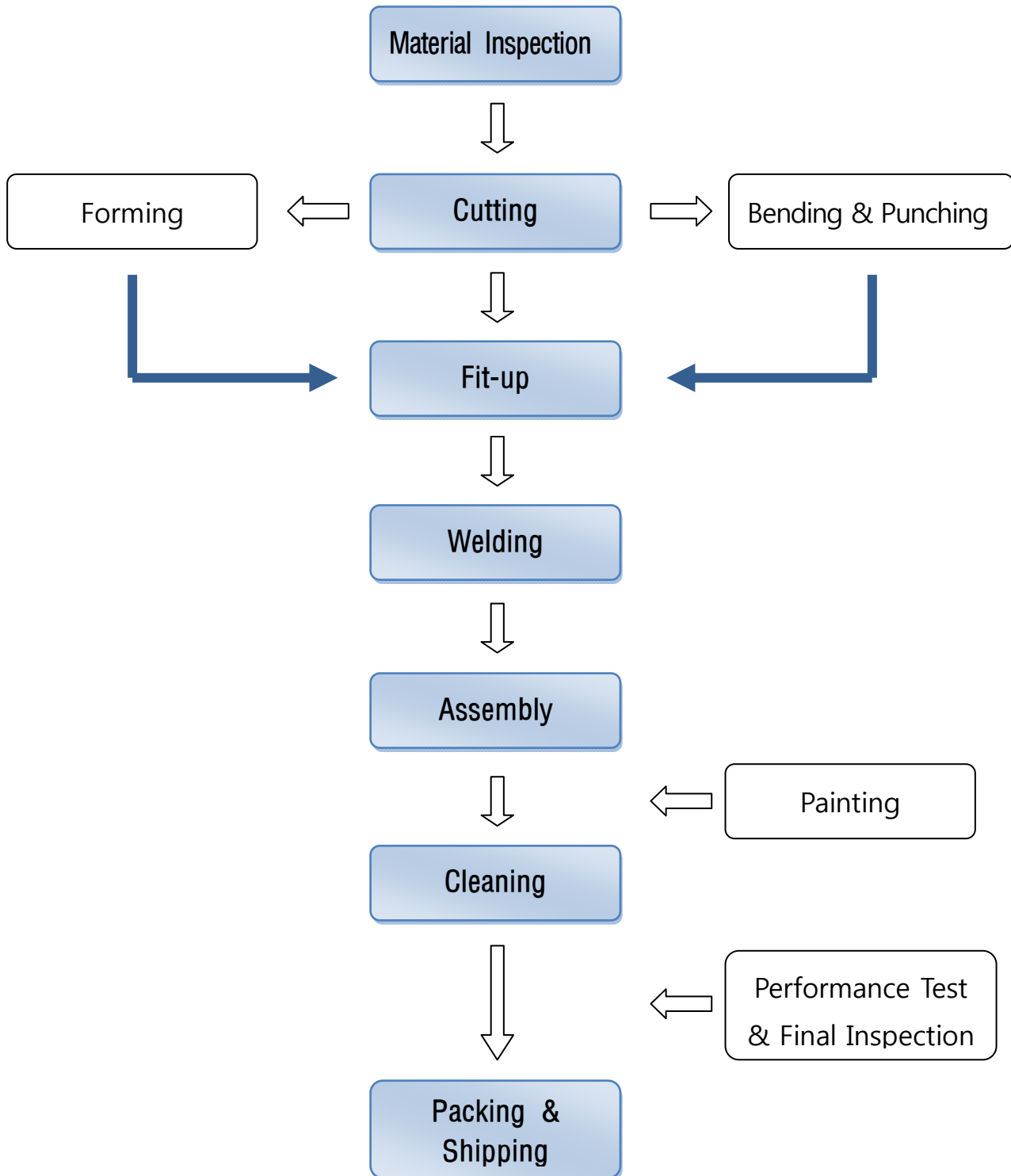



4. ORGANIZATION

4. Organization

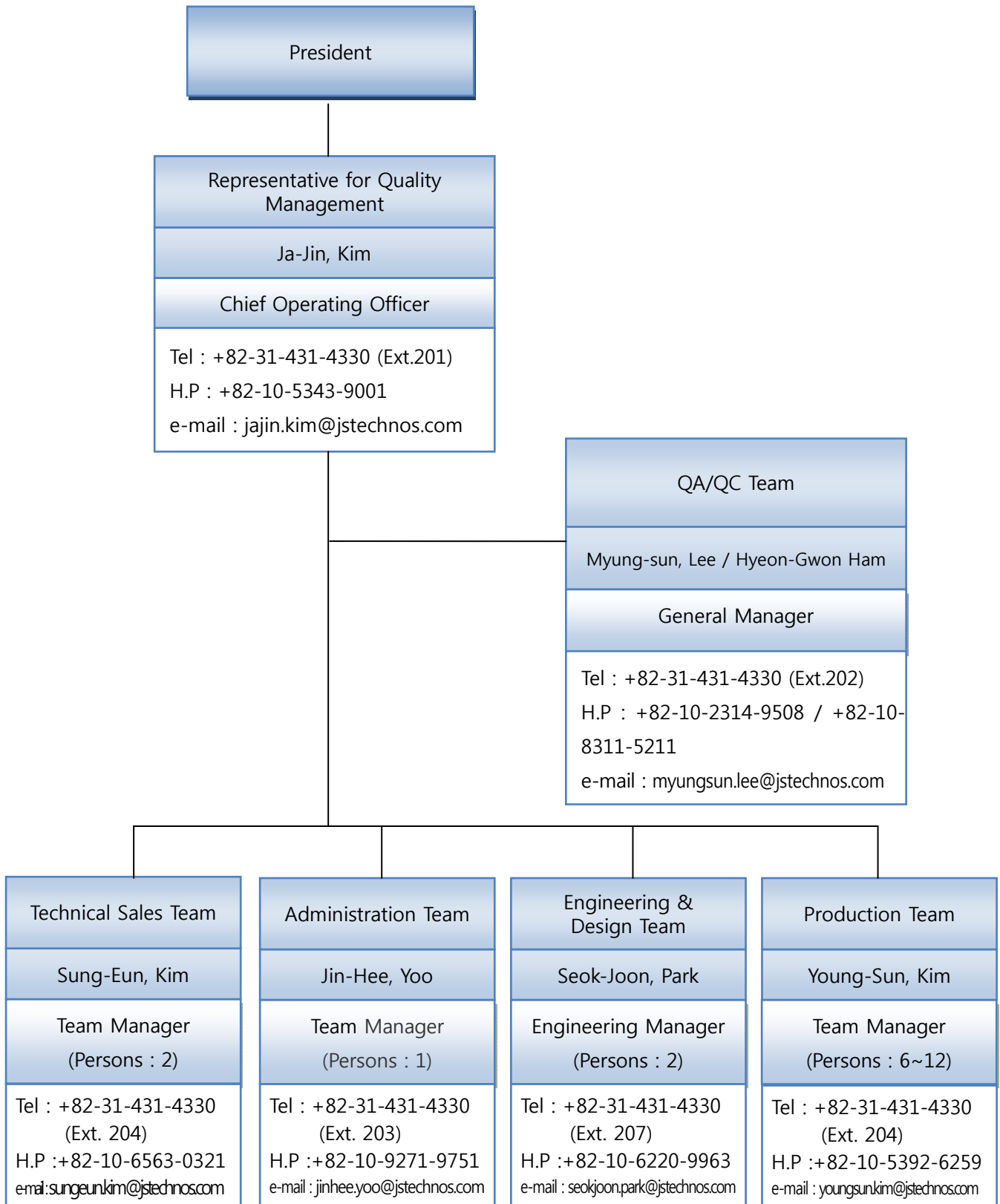

Manufacturing shop QC Organization

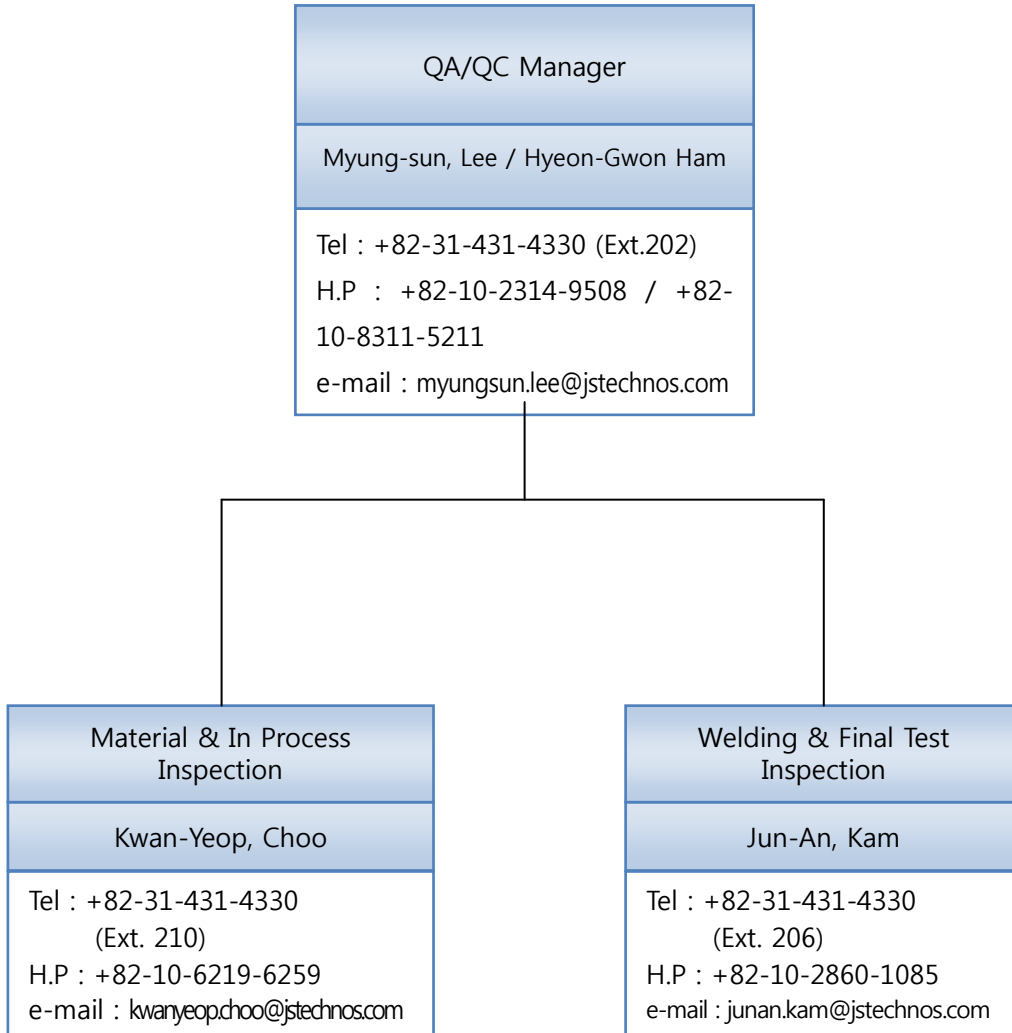



5. ENGINEERING PROGRAM

5. ENGINEERING PROGRAM

1. Silencer design (By Company Design System)

- Basic & Detail design
- Acoustical calculation
- Strength calculation for Shell and Head
- Strength calculation for Support lug
- Strength calculation for Lifting lug
- Strength calculation for Cross bar

2. Sound Enclosure design (By Company Design System)

- Basic & Detail design
- Acoustical calculation

3. Acoustic analysis (By RAYNOISE & Company Analysis System)

4. Pipe stress analysis (By PIPE PLUS)

5. Strength calculation (By PV Elite)

6. QUALIFIED TECHNICAL LICENSES OF EMPLOYEE

6. QUALIFIED TECHNICAL LICENCES OF EMPLOYEE

NO.	QUALIFICATION OF LICENCE	NUMBER	REMARKS
1.	1st Grade of Noise & Vibration Engineering	2	
2.	1st Grade of Design for Heavy Const. Equipment	1	
3.	1st Grade of Design for Machinery and Equipment	1	
4.	1st Grade of Quality Control	1	
5.	1st Grade of Welding Performance Qualification	2	
6.	1st Grade of Gas Welding Performance Qualification	2	
7.	Board of Technical Consultant for Noise and Vibration	2	



7. PRODUCTION EQUIPMENT LIST

7. PRODUCTION EQUIPMENT LIST

NO.	EQUIPMENT NAME	DESCRIPTION	Q'TY	REMARKS
1.	OVER HEAD CRANE	5 TON	2	
2.	TURNING ROLLER (AUTO)	70 TON	8	
3.	TURNING ROLLER (AUTO)	30 TON	1	
4.	TURNING ROLLER (AUTO)	20 TON	2	
5.	GRINDING MACHINE	2 HP	4	
6.	BENCH DRILLING MACHINE	50 MM	2	
7.	BENCH DRILLING MACHINE	22 MM	1	
8.	CO2 WELDING MACHINE	500 A	3	
9.	ARC WELDING MACHINE	7.5 KW	4	
10.	ARC WELDING MACHINE	15 KW	3	
11.	ARC WELDING MACHINE	20 KW	2	
12.	ARC WELDING MACHINE	25 KW	2	
13.	TIG WELDING MACHINE	500 AP	2	
14.	TIG WELDING MACHINE	300 AP	2	
15.	OXYGEN WELDER		3	
16.	HAND GRINDER	7"	4	
17.	HAND GRINDER	4"	4	
18.	BENDING ROLLER	12tx2500L	4	
19.	HAMMER DRILL	20 mm	1	
20.	BEVELLER	15 T	1	
21.	BENDING ROLLER	20T x 2000W	1	
22.	ELECTRIC CUTTER	18"	1	

8. INSPECTION & TESTING EQUIPMENT LIST

8. INSPECTION & TESTING EQUIPMENT LIST

NO.	EQUIPMENT NAME	DESCRIPTION	Q'TY	REMARKS
1.	SOUND LEVEL METER	NL - 42	1	RION - JAPAN
2.	1/1 & 1/3 OCTAVE BAND FILTER	NX - 42RT	1	RION - JAPAN
3.	SOUND LEVEL METER	NL - 22	1	RION - JAPAN
4.	1/1 & 1/3 OCTAVE BAND FILTER	NX - 22RT	1	RION - JAPAN
5.	PRINTER WITH CABLE	CP - 10	1	RION - JAPAN
6.	CALIBRATOR WITH 1/2" ADAPTOR	NC - 73	1	RION - JAPAN
7.	TRIPOD	ST - 80	1	RION - JAPAN
8.	MICROPHONE PREAMPLIFIER		1	RION - JAPAN
9.	NOISE GENERATOR	10 ~ 130 dB	1	CESVA, SPAIN
10.	NOISE GENERATOR	10 ~ 130 dB	1	HEOUN CHANG, KOREA
11.	SPEAKER	300W, 8Ω	3	TECH SOUND, KOREA
12.	CROSS CUT, ADHENSION TEST	AT-CC2000/ISO2	1	TQC B.V., NETHERLAND
13.	COATING THICKNESS GAUGE	1000 μm (MAX.)	1	COATEST
14.	COATING THICKNESS GAUGE (QNIX 4200)	3000 μm (MAX.)	2	AUTOMATION , JAPAN
15.	DIAL GAUGES	0~1 , 0.001mm	1	TESTEX
16.	CLAMP ON AC/DC HI TESTER	AC/DC 100~1000A AC/DC 100~1000V	1	HIOKI , JAPAN
17.	MICROMETER	0 - 25 MM	1	MITUTOYO
18.	MICROMETER	25 - 50 MM	1	MITUTOYO
19.	HEIGHT GAUGE	0 - 600	1	MITUTOYO
20.	RULES-STEEL TAPES		5	
21.	WEIGHT SCALE		2	
22.	LEVELER		4	



9. CERTIFICATE OF ISO 9001/14001



CERTIFICATE

Certificate no. 9714 / QSK no. 0817

JS TECHNOS CO., LTD.

**#57, MAYU-RO 70BEON-GIL, SIHUEUNG-SI, GYEONGGI-DO,
KOREA**

QS ZÜRICH AG certifies that the management system of the above mentioned company has been evaluated and meets the requirements established by the following rules:

ISO 9001: 2015

The management system includes:

**DESIGN, DEVELOPMENT, PRODUCTION AND SERVICING OF
NOISE VIBRATION CONTROL SYSTEM, INDUSTRIAL
SILENCER, ACOUSTIC ENCLOSURE, VESSEL & TANK,
PIPE HANGER & SUPPORT**

During the period of validity of this certificate, the management system of the company must always comply with the requirements of the certified standards.

For updated amendments within the scope of certification of the present certificate, please refer to <http://www.quality-service.ch/>



First certification date:	09.05.2013
Date of issue:	18.05.2018
Expiration date:	17.05.2021
Subject to successful surveillance audit	

QS ZÜRICH AG
P.O. Box 6335
CH-8050 Zürich
info@quality-service.ch



Management



CERTIFICATE

Certificate no. 8115 / QSK no. 5340

JS TECHNOS CO., LTD.

**#57, MAYU-RO 70BEON-GIL, SIHUEUNG-SI, GYEONGGI-DO,
KOREA**

QS ZÜRICH AG certifies that the management system of the above mentioned company has been evaluated and meets the requirements established by the following rules:

ISO 14001: 2015

The management system includes:

**DESIGN, DEVELOPMENT, PRODUCTION AND SERVICING OF
NOISE VIBRATION CONTROL SYSTEM, INDUSTRIAL
SILENCER, ACOUSTIC ENCLOSURE, VESSEL & TANK, PIPE
HANGER & SUPPORT**

During the period of validity of this certificate, the management system of the company must always comply with the requirements of the certified standards.

For updated amendments within the scope of certification of the present certificate, please refer to <http://www.quality-service.ch/>



First certification date: 09.05.2012
Date of issue: 18.05.2018
Expiration date: 18.05.2021
Subject to successful surveillance audit

QS ZÜRICH AG
P.O. Box 6335
CH-8050 Zürich
info@quality-service.ch



Management

10. MAJOR REFERENCE LIST (SILENCER PART)

REFERENCE LIST

NO.	CUSTOMER	PROJECT NAME	YEAR	ITEM NAME
1	DAEKYUNG MACHINERY & ENGINEERING CO., LTD.	INDONESIA, TPPI TUBAN AROMATIC PROJECT – HRSG	2005	STACK SILENCER
2	DAEKYUNG MACHINERY & ENGINEERING CO., LTD.	THAILAND, IHI SCG PCL EXPANSION PROJECT-2,	2005	STEAM / STACK SILENCER
3	DAEKYUNG MACHINERY & ENGINEERING CO., LTD.	JAPAN, IHI, GTF PROJECT	2005	STEAM / STACK SILENCER
4	KANGWON BOILER MFG. CO., LTD.	HANSOL HOMETECO PROJECT	2005	STEAM SILENCER
5	DONGBO HEAVY IND. CO., LTD.	KWANGYANG CCPP – HRSG	2005	STEAM SILENCER
6	SAMSHIN IND. CO., LTD.	LG-PHILLIPS LCD 36T/H BOILER	2005	STEAM SILENCER
7	BUMWOO ENG CO., LTD.	LIBYA, BENGHAZI NORTH CCPP	2005	STEAM SILENCER
8	SAMSHIN IND. CO., LTD.	YONGSAN CHEMICAL PROJECT	2005	STEAM SILENCER
9	SAMSUNG ENGINEERING CO., LTD.	HYCO 1 PLANT PROJECT	2005	STEAM SILENCER
10	DAEWOO E&C CO., LTD.	INCHEON SONGDO CCPP	2005	STEAM SILENCER
11	ILSUNG ENGINEERING CO., LTD.	KIER PROJECT	2005	STEAM SILENCER
12	DAEKYUNG MACHINERY & ENGINEERING CO., LTD.	IHI, GTF PROJECT, JAPAN	2005	STEAM / STACK SILENCER
13	KANGWON BOILER CO., LTD.	LIBYA, ZAWAI CCPP	2005	STEAM SILENCER
14	KANGWON BOILER CO., LTD.	ASPEX PROJECT	2005	STEAM SILENCER
15	DAEKYUNG MACHINERY & ENGINEERING CO., LTD.	PYUNGTAEK THERMAL POWER PLANT – HRSG	2005	STEAM SILENCER
16	KANGWON BOILER CO., LTD.	YANGSAN INCINERATOR PROJECT	2005	STEAM SILENCER
17	PRAXAIR KOREA CO., LTD.	GIHYUNG PLANT	2005	GAS SILENCER
18	SAMSUNG ENGINEERING CO., LTD.	PEMEX MINATITLAN PROJECT	2005	STEAM / AIR SILENCER
19	DAEKYUNG MACHINERY & ENGINEERING CO., LTD.	JAPAN, IHI, GTF PROJECT(STEP 2) – HRSG	2006	STEAM / STACK SILENCER
20	KENERTEC CO., LTD.	WEST DAEGU BIO CCPP	2006	STEAM SILENCER
21	KOREA COMBUSTION CO., LTD.	CHINA, LG BOHAI CHEMICAL PLANT	2006	STEAM SILENCER
22	DAEKYUNG MACHINERY & ENGINEERING CO., LTD.	JAPAN, IHI, NCP PROJECT – HRSG	2006	STEAM / STACK SILENCER

NO.	CUSTOMER	PROJECT NAME	YEAR	ITEM NAME
23	KANGWON BOILER CO., LTD.	YOUNGPOONG SP TSL PROJECT	2006	STEAM SILENCER
24	SAMSUNG ENGINEERING CO., LTD.	KSA, APPC PDH/PP PROJECT (544 T/Hr, 305T/H etc.)	2006	STEAM / AIR SILENCER
25	KANGWON BOILER CO., LTD.	KSA, APPC PDH/PP PROJECT	2006	STEAM SILENCER
26	SAMSUNG ENGINEERING CO., LTD.	STC PP#2 EXPANSION PROJECT	2006	STEAM SILENCER
27	KANGWON BOILER CO., LTD.	QATAR, LAFFAN REFINERY PROJECT	2006	STEAM SILENCER
28	SAMSHIN ENC CO., LTD.	SK SW PROJECT	2006	STEAM SILENCER
29	SAMSUNG ENGINEERING CO., LTD.	STC, G1 NCC EXPANSION PROJECT	2006	STEAM SILENCER
30	DONG-A MACHINERY INDUSTRIAL CO., LTD.	KOREA PAPER INCINERATOR	2006	STEAM SILENCER
31	DONG-A MACHINERY INDUSTRIAL CO., LTD.	ASIA PAPER TECH INCINERATOR	2006	STEAM SILENCER
32	LIOT CO., LTD.	ANYANG GS POWER	2006	STEAM SILENCER
33	SAMSHIN ENC CO., LTD.	LG MMA PROJECT	2007	STEAM SILENCER
34	KENERTEC CO., LTD.	WEST DAEGU BIO CCPP (2'ND)	2007	STEAM SILENCER
35	CORNA CO., LTD.	MEXICO, MXCB CO-GEN PROJECT	2007	STEAM SILENCER
36	SOOKOOK CO., LTD	CENTURY CO-GEN POWER PLANT	2007	STEAM SILENCER
37	DAELIM ROYAL BOILER CO., LTD.	GIMCEON CITY INCINERATOR	2007	STEAM SILENCER
38	SEONGHWA INDUSTRIES CO., LTD.	BUGOK II CCPP	2007	STEAM SILENCER
39	SEONGHWAINDUSTRIES CO., LTD.	THAILAND, SONGKHLA CCPP	2007	STEAM SILENCER
40	DAELIM BOILER CO., LTD.	EGYPT, ELAB PROJECT	2007	STEAM SILENCER
41	DONGBO HEAVY IND. CO., LTD.	GS CALTEX PROJECT	2007	STEAM SILENCER
42	HANKOOK BOILER CO., LTD.	GUNJANG CO-GEN PROJECT	2007	STEAM SILENCER
43	DONGBO HEAVY IND. CO., LTD.	INCHUN NONHYUN MAIN BOILER PROJECT	2007	STEAM SILENCER
44	SAMSHIN ENC CO., LTD.	SKC HPPO PROJECT	2007	STEAM SILENCER
45	DONGBO HEAVY IND. CO., LTD.	YOUNGPOONG SP 36T/H BOILER	2007	STEAM SILENCER
46	SAMSUNG ENGINEERING CO., LTD.	LPC DAESAN SEG PROJECT	2007	STEAM SILENCER

NO.	CUSTOMER	PROJECT NAME	YEAR	ITEM NAME
47	BUMWOO ENG CO., LTD.	BUSAN JEUNGKWAN CO-GEN. PROJECT	2007	STEAM / STACK SILENCER
48	KANGWON BOILER CO., LTD.	LPC SEG PROJECT	2007	STEAM SILENCER
49	KANGWON BOILER CO., LTD.	YOUNGPOONG SP PROJECT	2007	STEAM SILENCER
50	SEONGHWA INDUSTRIES CO., LTD.	BUGOK II CCPP (2'ND)	2007	STEAM SILENCER
51	KANGWON BOILER CO., LTD.	IRAN, SOUTH PARS PHASE 9&10	2007	FAN SILENCER
52	HANWHA ENGINEERING & CONSTRUCTION	GUNJANG CO-GEN PROJECT	2007	STEAM SILENCER
53	SAMSUNG ENGINEERING CO., LTD.	PETROTRIN NHK & CCR COMPLEX	2008	STEAM SILENCER
54	GKT CO., LTD.	RESIDUE HYDROSULFURIZATION PROJECT	2008	STEAM SILENCER
55	HANKOOK BOILER CO., LTD.	KOREA PETROCHEMICAL 100T/H BOILER	2008	STEAM SILENCER
56	SEONGHWA INDUSTRIES CO., LTD.	KSA, AL-SHUAIBAH CCPP	2008	STEAM SILENCER
57	HANKOOK BOILER TECH. CO., LTD.	PANGYO CLEAN TOWER	2008	STEAM SILENCER
58	KANGWON BOILER CO., LTD.	GS CALTEX HOU PROJECT	2008	STEAM SILENCER
59	BUMWOO ENG CO., LTD.	PCS PROJECT	2008	STEAM SILENCER
60	BUMWOO ENG CO., LTD.	CHILLE, GUACOLDA POWER PLANT	2008	STEAM SILENCER
61	BUMWOO ENG CO., LTD.	CHILLE, NUEVA VENTANAS 240MW COAL FIRED POWER PROJECT	2008	STEAM SILENCER
62	HYUNDAI ENGINEERING & CONSTRUCTION CO., LTD.	BUSAN JEUNGKWAN CO-GEN. PROJECT	2008	STEAM SILENCER
63	BUMWOO ENG CO., LTD.	DONGNAM CO-GEN. PROJECT - HRSG	2008	STEAM / STACK SILENCER
64	DAELIM BOILER CO., LTD.	CHUNGJU INCINERATOR PROJECT	2008	STEAM SILENCER
65	DAELIM BOILER CO., LTD.	MASAN INCINERATOR PROJECT	2008	STEAM SILENCER
66	KANGWON B&E CO., LTD.	SHIN-KORI NUCLEAR POWER PLANT 1&2	2008	STEAM SILENCER
67	DAEKYUNG MACHINERY & ENGINEERING CO., LTD.	KWANGMYUNG - HRSG	2008	STEAM / STACK SILENCER
68	HWASEONG BOILER CO., LTD.	YONGIN-SI WASTE BOILER PROJECT	2008	STEAM SILENCER
69	KANGWON BOILER CO., LTD.	KOYANG-SI INCINERATION PLANT	2008	STEAM SILENCER
70	KENERTEC CO., LTD.	DAEGU WOOD CHIP PROJECT	2008	STEAM SILENCER

NO.	CUSTOMER	PROJECT NAME	YEAR	ITEM NAME
71	KANGWON B&E CO., LTD.	GS CALTEX CORP. PACKAGE BOILER EXPANSION PROJECT	2008	STEAM SILENCER
72	HANSHIN BOILER CO., LTD.	DONGNAM CO-GEN. PROJECT	2008	STEAM SILENCER
73	DAELIM BOILER CO.,LTD.	25TON/HR BOILER PROJECT	2008	STEAM SILENCER
74	DAEWOO E&C CO., LTD.	IKSAN INCINERATOR PROJECT	2008	STEAM SILENCER
75	SAMSUNG ENGINEERING CO., LTD.	KSA, MA'ADEN AMMONIA PROJECT	2008	STEAM SILENCER
76	SAMSUNG ENGINEERING CO., LTD.	UAE, BOROUGE 2 OCU PROJECT	2008	STEAM SILENCER
77	BUMWOO ENG CO., LTD.	POSCO, GWANGYANG 3,4 SINTERING PROJECT	2009	STEAM SILENCER
78	SEENTEC CO., LTD.	ASAN COMBINED HEAT & POWER PLANT – HRSG	2009	STEAM / STACK SILENCER
79	HANWHA ENGINEERING & CONSTRUCTION	OXY4 PROJECT	2009	STEAM SILENCER
80	KANGWON B&E CO., LTD.	YEOSU INCINERATION PROJECT	2009	STEAM SILENCER
81	HANSHIN BOILER CO., LTD.	HAMAN CITY INCINERATION PROJECT	2009	STEAM SILENCER
82	BHI CO., LTD.	POSCO NEW STEEL MANUFACTURE PROJECT	2009	STEAM SILENCER
83	HANWHA ENGINEERING & CONSTRUCTION	KSA, MA'ADEN POWER & DESALINATION PROJECT	2009	STEAM SILENCER
84	HANSHIN BOILER CO., LTD.	EXTENSION OF FORDON WASTE WATER TREATMENT PLANT	2009	STEAM SILENCER
85	BHI CO., LTD.	POSCO HEAVY PLATE CAPACITY REINFORCEMENT PROJECT	2009	STEAM SILENCER
86	DAEKYUNG MACHINERY & ENGINEERING CO., LTD.	THAILAND, SIPCO 160MW CCPP – HRSG	2009	STEAM / STACK SILENCER
87	ILSUNG CORPORATION	INDONESIA, CIREBON COAL POWER PLANT – AUX. BOILER	2009	STEAM SILENCER
88	SAMSHIN ENC CO., LTD.	THAILAND, AOG UINT OF AN AND MMA ROJECT	2009	STEAM SILENCER
89	ILSUNG CORPORATION	KG ENERGY HEART PROJECT I	2009	STEAM SILENCER
90	KANGWON B&E CO., LTD.	GS-CALTEX EXPANSION PROJECT	2009	STEAM SILENCER
91	HANWHA ENGINEERING & CONSTRUCTION	KSA, MA'ADEN POWER & DESALINATION PROJECT (2'ND)	2009	STEAM SILENCER
92	KANGWON B&E CO., LTD.	SHIN-WOLSONG NUCLEAR POWER PLANT 1&2	2009	STEAM SILENCER
93	WOORYANG HC CO., LTD.	GP PROJECT	2009	STEAM SILENCER
94	DONGBO HEAVY IND. CO., LTD.	POSCO POWER UNIT 5&6 CCPP – AUX. BOILER	2009	STEAM SILENCER

NO.	CUSTOMER	PROJECT NAME	YEAR	ITEM NAME
95	SAMSUNG ENGINEERING CO., LTD.	BAHRAIN, BAPCO LUBE BASE OIL PROJECT	2009	STEAM SILENCER
96	SAMSUNG ENGINEERING CO., LTD.	KSA, MA'ADEN AMMONIA PROJECT (2'ND)	2009	STEAM/ GAS SILENCER
97	BHI CO., LTD.	PAJU COMBINED HEAT & POWER PLANT – HRSG	2009	STEAM / STACK SILENCER
98	SAMSHIN ENC CO., LTD.	CHINA. NINGBO PVC PROJECT	2009	STEAM SILENCER
99	SAMSUNG C&T CORPORATION	STC JET A-1 PROJECT	2010	STEAM SILENCER
100	BHI CO., LTD.	FINEX 2 PROJECT	2010	STEAM SILENCER
101	SAMSHIN ENC CO., LTD.	SWI #3 HOU PROJECT	2010	STEAM SILENCER
102	BHI CO., LTD.	UAE, SHUWEIHAT S2 IWPP	2010	STEAM SILENCER
103	BHI CO., LTD.	POSCO HEAVY PLATE CAPACITY REINFORCEMENT PROJECT	2010	STEAM SILENCER
104	SHINHAN ENGINEERING CO., LTD.	BIOMASS INCINERATION PROJECT	2010	STEAM SILENCER
105	SPIRAXSARCO CO., LTD.	GUNSAN OCI PILOT PROJECT	2010	STEAM SILENCER
106	HANYANG INDUSTRY CO., LTD.	PANGYO CHPP PROJECT	2010	AIR SILENCER
107	BHI CO., LTD.	POSCO POWER UNIT 5&6 CCPP – HRSG	2010	STEAM SILENCER
108	HANKOOK B&TEC CO., LTD.	KUMI CITY INCINERATION PROJECT	2010	STEAM SILENCER
109	SAMSHIN ENC CO., LTD.	HDO #2 HOU PROJECT	2010	STEAM SILENCER
110	HANKOOK B&TEC CO., LTD	ALKHALIJ 4x350MW POWER PLANT – AUX. BOILER	2010	STEAM SILENCER
111	WOORYANG HC CO., LTD.	ALGERIA, ARZEW REFINERY PROJECT	2010	STEAM SILENCER
112	SEOUL SHARP HEAVY INDUSTRIES CO., LTD.	HONGWON PAPER MFG 50T/H PC BOILER	2010	STEAM SILENCER
113	LINDE KOREA CO., LTD.	HWASUNG 2 PROJECT	2010	INLINE SILENCER
114	BHI CO., LTD.	EGYPT, ABU-QIR TPP 6&7 (650MWx2)	2010	STEAM SILENCER
115	SAMSHIN ENC CO., LTD.	KITECH 20T/H BOILER PROJECT	2010	STEAM SILENCER
116	SAMSUNG TOTAL PETRO-CHEMICALS CO., LTD.	NCC BA113 PROJECT	2010	STEAM SILENCER
117	DAEKYUNG MACHINERY & ENGINEERING CO., LTD.	GOYANG/SAMSUNG COMBINED HEAT& POWER PLANT – HRSG	2010	STEAM / STACK SILENCER
118	SPIRAXSARCO CO., LTD.	GUNSAN OCI P3 PROJECT	2010	STEAM SILENCER

NO.	CUSTOMER	PROJECT NAME	YEAR	ITEM NAME
119	DAELIM BOILER CO.,LTD.	KEPPACK OSAN FACTORY 35T/H BOILER	2010	STEAM SILENCER
120	SHINHAN ENGINEERING CO., LTD.	TAEBAEK CITY INCINERATION PROJECT	2010	STEAM SILENCER
121	HANKOOK B&TEC CO., LTD	LG-CHEM, PAJU FACTORY 27.5T/H BOILER	2010	STEAM SILENCER
122	SEOUL SHARP HEAVY INDUSTRIES CO., LTD.	S-OIL, REFINERY EXPANSION PROJECT	2010	STEAM SILENCER
123	SAMSUNG ENGINEERING CO., LTD.	KSA, ARAMCO RAS TANURA DHT PROJECT	2010	STEAM SILENCER
124	DAEYEOL BOILER CO.,LTD.	GWANGJU, INCINERATION 18T/H BOILER	2010	STEAM SILENCER
125	SAMSUNG ENGINEERING CO., LTD.	KSA, JUBAIL EXPORT REFINERY PROJECT-PKG #3 AROMATICS UNITS	2010	STEAM SILENCER
126	BHI CO., LTD.	BUSAN JEUNGKWAN CO-GEN. PROJECT (2'ND)	2010	STEAM / STACK SILENCER
127	KANGWON B&ECO., LTD.	NAMYANGJU CLEAN-CENTER PROJECT	2011	STEAM SILENCER
128	DONGBO HEAVY IND. CO., LTD.	SHIN-KORI NUCLEAR POWER PLANT 3&4	2011	STEAM SILENCER
129	KANGWON B&ECO., LTD.	NAMYANGJU CLEAN-CENTER PROJECT	2011	STEAM SILENCER
130	DONGBO HEAVY IND. CO., LTD.	SHIN-KORI NUCLEAR POWER PLANT 3&4	2011	STEAM SILENCER
131	SAMSUNG ENGINEERING CO., LTD.	PETROTRIN, ULTRA LOW SULPHUR DIESEL UNIT PROJECT	2011	STEAM SILENCER
132	SAMSUNG TOTAL PETRO-CHEMICALS CO., LTD.	HP STEAM EXHAUST SILENCER	2011	STEAM SILENCER
133	SPIRAX SARCO CO., LTD.	GUNSAN OCI P3.5 PROJECT	2011	STEAM SILENCER
134	SAMSUNG ENGINEERING CO., LTD.	KSA, SABIC, GAS JUBAIL PHASE-VIII PROJECT	2011	STEAM / GAS SILENCER
135	SAMSHIN ENC CO., LTD.	TURKMENISTAN, GAS DESULFURIZATION PLANT	2011	STEAM SILENCER
136	DONGBO HEAVY IND. CO., LTD.	IKSAN INDUSTRIAL COMPLEX II CES PROJECT	2011	STEAM SILENCER
137	HANSHIN BOILER CO., LTD.	POHANG OCI 45T/H BOILER	2011	STEAM SILENCER
138	DAEKYUNG MACHINERY & ENGINEERING CO., LTD.	PAKISTAN, LOTTE PPTA CO-GENERATION PROJECT - HRSG	2011	STEAM / STACK SILENCER
139	KANGWON B&E CO., LTD.	IRAN, KAVEH METHANOL PLANT PROJECT	2011	STEAM SILENCER
140	SEENTEC CO., LTD.	THAILAND, NATIONAL POWER 2 SPP POWER PROJECT - HRSG	2011	STEAM SILENCER
141	HANSHIN BOILER CO., LTD.	NO.1 TAC COMMERCIAL PLANT	2011	STEAM SILENCER
142	SPIRAXSARCO CO.,LTD.	S-OIL, INSTALLATION OF TVR	2011	INLINE SILENCER

NO.	CUSTOMER	PROJECT NAME	YEAR	ITEM NAME
143	HANKOOK B&TEC CO., LTD.	GIMPO HANGANG NEW CITY CLEAN-CENTER PROJECT	2011	STEAM SILENCER
144	SAMSUNG ENGINEERING CO., LTD.	UAE, FERTIL-2 AMMONIA/UREA EXPANSION PROJECT	2011	GAS/STEAM SILENCER
145	KANGWON B&E CO., LTD.	OMAN, SOHAR 2 INDEPENDENT POWER PLANT	2011	STEAM SILENCER
146	HANKOOK B&TEC CO., LTD.	YEOSU CO-GENERATION POWER PLANT PROJECT	2011	STEAM SILENCER
147	HANSHIN BOILER CO., LTD.	BSP(BATTERY SEOSAN PLANT) PROJECT	2011	STEAM SILENCER
148	KANGWON B&ECO., LTD.	OMAN, BARKA 3 INDEPENDENT POWER PLANT	2011	STEAM SILENCER
149	SHINHAN ENGINEERING CO., LTD.	YULCHON FCBL.2 5.6MW POWER PLANT	2011	STEAM SILENCER
150	BHI CO., LTD.	NNE CCGT SPP PROJECT	2011	STEAM SILENCER
151	SAMSUNG ENGINEERING CO., LTD.	KSA, SAMCO ACRYLIC ACID PROJECT	2011	STEAM SILENCER
152	SEDAE ENERTECH CO., LTD.	KWANGGYO COMBINED HEAT & POWER PLANT – HRSG	2011	STACK SILENCER
153	SAMSUNG ENGINEERING CO., LTD.	ALGERIA, SKIKDA REFINERY PROJECT	2011	STEAM SILENCER
154	HALLA ENERGY & ENVIRONMENT	IKSAN INDUSTRIAL COMPLEX II CES PROJECT	2011	STEAM SILENCER
155	SAMSUNG ENGINEERING CO., LTD.	UAE, SHAH GAS DEVELOPMENT PKG.4 U&O	2011	STEAM SILENCER
156	SAMSUNG ENGINEERING CO., LTD.	KSA, MA'ADEN AMMONIA PROJECT (3'RD)	2011	GAS SILENCER
157	HANKOOK B&TEC CO., LTD.	OSEONG COMBINED CYCLE POWER PLANT	2012	STEAM SILENCER
158	SAMSUNG ENGINEERING CO., LTD.	UAE, FERTIL-2 AMMONIA/UREA EXPANSION PROJECT (2'ND)	2012	STEAM SILENCER
159	KANGWON B&E CO., LTD.	IRAN, KAVEH SODA PLANT PROJECT	2012	STEAM SILENCER
150	SHINHAN ENGINEERING CO., LTD.	YANGSAN, HANCHANG PAPER 45T/H BOILER PROJECT	2012	STEAM SILENCER
161	KANGWON B&E CO., LTD.	GSC, VGO FCC PROJECT	2012	STEAM SILENCER
162	DAEKYUNG MACHINERY & ENGINEERING CO., LTD.	MALAYSIA, KIMANIS 300MW CCPP – HRSG	2012	STEAM / STACK SILENCER
163	J TECH CO., LTD.	SINGAPORE, GMR ENERGY 2 x 400MW CCPP	2012	STEAM SILENCER
164	HANSHIN BOILER CO., LTD.	POSCO E&C, MEXICO No.2 CGL(EP) PLANT	2012	STEAM SILENCER
165	SAMSHIN ENC CO., LTD.	TS-7000(No.4 AN PROJECT) PROJECT	2012	STEAM SILENCER
166	DAEKYUNG MACHINERY & ENGINEERING CO., LTD.	INDONESIA, KERAMASAN POWER PLANT EXTENSION PROJECT – HRSG	2012	STEAM SILENCER

NO.	CUSTOMER	PROJECT NAME	YEAR	ITEM NAME
167	SEENTEC CO., LTD.	NAMYANGJU BYEOLLAE CHPP – HRSG	2012	STACK / STEAM SILENCER
168	SAMSHIN ENC CO., LTD.	2D(YEOSU MMA) PROJECT	2012	STEAM SILENCER
169	BHI CO., LTD.	BUGOK 3 CCPP – HRSG	2012	STEAM / STACK SILENCER
170	SVC INC.	MOROCCO, JORF LASFAR UNIT 5&6	2012	STEAM SILENCER
171	HANSHIN BOILER CO., LTD.	SINGAPORE, GMR ENERGY 2 x 400MW CCPP	2012	STEAM SILENCER
172	HANWHA ENGINEERING & CONSTRUCTION	HCC, ORANGE PROJECT	2012	STEAM SILENCER
173	DAEKYUNG MACHINERY & ENGINEERING CO., LTD.	KSA, YANBU 2 POWER AND WATER PROJECT	2012	STEAM SILENCER
174	HANWHA ENGINEERING & CONSTRUCTION	HCC, ORANGE PROJECT – SILENCER 2	2012	STEAM SILENCER
175	HYUNDAI ENGINEERING & CONSTRUCTION CO., LTD.	UAE, BOROUGE 3 UTILITIES & OFFSITES PROJECT	2012	STEAM SILENCER
176	HANWHA ENGINEERING & CONSTRUCTION	KSA, YANBU 2 POWER AND WATER PROJECT	2012	STEAM SILENCER
177	DONGBO HEAVY IND. CO., LTD.	BAHRAIN, MUHARRAQ STP AND SEWER CONVEYANCE SYSTEM	2012	STEAM SILENCER
178	DAELIM INDUSTRIAL CO., LTD.	KUM-HO YDR-S-1 SSBR PROJECT	2012	STEAM SILENCER
179	SAMSUNG PETROCHEMICAL CO., LTD.	SEOSAN, CATOX FUEL INNOVATION PROJECT	2012	STEAM SILENCER
180	SAMSUNG ENGINEERING CO., LTD.	KSA, SHAYBAH NGL#2 RECOVERY & UTILITIES PROJECT	2012	STEAM SILENCER
181	KANGWON B&E CO., LTD.	PHILLIPINE, REFINERY MASTER PLAN 2 PROJECT (RMP-2)	2012	STEAM SILENCER
182	HANKOOK B&TEC CO., LTD.	OMAN, MUSANDAM GAS POWER PLANT – AUX. BOILER	2012	STEAM SILENCER
183	KANGWON B&E CO., LTD.	YULCHON II CCPP EXTENSION (960MW) PROJECT	2012	STEAM SILENCER
184	SC ENGINEERING CO., LTD.	T-5 F-BOILER & De-Sox PACKAGE PROJECT	2012	STEAM SILENCER
185	SPX FT KOREA	KSA, SHAYBAH NGL#2 RECOVERY & UTILITIES PROJECT	2012	AIR SILENCER
186	HYUNDAI ENGINEERING & CONSTRUCTION CO., LTD.	OMAN, MUSANDAM GAS POWER PLANT	2012	STEAM SILENCER
187	SUN PLANT ENGINEERING CO., LTD.	LG CHEM BPA PROJECT	2013	STEAM SILENCER
188	HANSHIN BOILER CO., LTD.	VIETNAM, MONG DUONG II 2x560MW(NET) COAL FIRED POWER PROJECT	2013	STEAM SILENCER
189	SAMSHIN ENC CO., LTD.	SFC, 60,000 MTPA ECH NO.2 PLANT (INC)	2013	STEAM SILENCER
190	SAMSUNG ENGINEERING CO., LTD.	KSA, MA'ADEN ALUMINA REFINERY STEAM PLANT PROJECT	2013	STEAM SILENCER

NO.	CUSTOMER	PROJECT NAME	YEAR	ITEM NAME
191	HANKOOK B&TEC CO., LTD.	CHANGWON CITY INCINERATION PROJECT	2013	STEAM SILENCER
192	HYUNDAI ENGINEERING & CONSTRUCTION CO., LTD.	HYUNDAI GREEN POWER STEEL TPP UNIT 5~8 (100MW x 4)	2013	STEAM SILENCER
193	J TECH CO., LTD.	KSA, QURAYYAH INDEPENDENT POWER PLANT	2013	STEAM SILENCER
194	BHI CO., LTD.	POSCO KWANGYANG, No.4 HSM PLANT	2013	STEAM SILENCER
195	DONGBO HEAVY IND. CO., LTD.	YEONGHEUNG THERMAL POWER PLANT UNIT 5&6 (870MW x 2)	2013	STEAM SILENCER
196	BHI CO., LTD.	ANDONG CCPP PROJECT – HRSG	2013	STACK SILENCER
197	SAMSHIN ENC CO., LTD.	MONG DUONG I THERMAL POWER PLANT	2013	STEAM SILENCER
198	HYUNDAI ENGINEERING & CONSTRUCTION CO., LTD.	YULCHON II COMBINED CYCLE POWER PLANT	2013	STEAM SILENCER
199	SAMSHIN ENC CO., LTD.	STC, NO.2 AROMATICS COMPLEX PROJECT	2013	STEAM SILENCER
200	KANGWON B&E CO., LTD.	REFINERY MASTER PLAN 2 PROJECT (RMP-2, 2'ND)	2013	STEAM SILENCER
201	BHI CO., LTD.	ANDONG CCPP PROJECT – HRSG	2013	STACK SILENCER
202	SAMSUNG ENGINEERING CO., LTD.	SMP W-1 PROJECT	2013	STEAM SILENCER
203	HANSHIN BOILER CO., LTD.	ANDONG CCPP PROJECT – AUX BOILER	2013	STEAM SILENCER
204	SAMSUNG ENGINEERING CO., LTD.	INDONESIA, MCL BANYU URIP PROJECT EPC1 PPF	2013	STEAM SILENCER
205	SC ENGINEERING CO., LTD.	SUDOKWON LANDFILL SITE 5MW BIOGAS COGEN PROJECT	2013	STEAM SILENCER
206	WELCRON KANGWON CO., LTD.	INDONESIA, BANYU URIP PROJECT	2013	STEAM SILENCER
207	HANSHIN ENGINEERING CO., LTD.	ULSAN OIL-FIRED & C.C POWER COMPLEX FUEL CELL SYSTEM	2013	STEAM SILENCER
208	DAEKYUNG MACHINERY & ENGINEERING CO., LTD.	JAPAN, IHI SNP PROJECT	2013	STEAM / STACK SILENCER
209	SAMSUNG FINE CHEMICALS CO., LTD.	60,000 MTPA ECH NO.2 PLANT	2013	STEAM SILENCER
210	DAEKYUNG MACHINERY & ENGINEERING CO., LTD.	UZBEKISTAN, UGCC U&O PROJECT	2013	STACK SILENCER
211	SAMSUNG ENGINEERING CO., LTD.	KSA, WASIT GAS PLANT CO-GENERATION & STEAM GENERATION	2013	STEAM SILENCER
212	BHI CO., LTD.	POSCOENERGY CCPP UNIT 7,8,9 – HRSG(UNIT 7)	2013	STEAM SILENCER
213	DAELIM INDUSTRIAL CO., LTD.	KSA, SHOAIBA II CCPP	2013	STEAM SILENCER
214	SEDAE ENERTECH CO., LTD.	ULSAN #4 COMBINED CYCLE POWER PLANT – HRSG	2013	STACK SILENCER

NO.	CUSTOMER	PROJECT NAME	YEAR	ITEM NAME
215	WELCRON KANGWON CO., LTD.	UZBEKISTAN, UGCC U&O PROJECT	2013	STEAM SILENCER
216	BHI CO., LTD.	POSCOENERGY CCPP UNIT 7,8,9 – HRSG(UNIT 8)	2013	STEAM SILENCER
217	DAEKYUNG MACHINERY & ENGINEERING CO., LTD.	UZBEKISTAN, UGCC U&O PROJECT – HRSG	2013	STEAM SILENCER
218	HANWHA ENGINEERING & CONSTRUCTION	KSA, YANBU 2 POWER AND WATER PROJECT(2'ND, MED STEAM)	2013	STEAM SILENCER
219	KC COTTRELL CO., LTD.	KOSPO, HADONG POWER PLANT – 10MW CCS PROJECT	2013	STEAM SILENCER
220	DAEKYUNG MACHINERY & ENGINEERING CO., LTD.	DAEGU DYEING INDUSTRIAL CENTER – AUX. BOILER(LNG 200T/H)	2013	STEAM SILENCER
221	HANKOOK B&TEC CO., LTD.	SAMCHEOK GREEN POWER PLANT UNIT 1&2 – AUX. BOILER	2013	STEAM SILENCER
222	DAEKYUNG MACHINERY & ENGINEERING CO., LTD.	JAPAN, IHI KANEKA PROJECT	2013	STEAM / STACK SILENCER
223	BHI CO., LTD.	MYANMAR POWER GENERATION PLANT PROJECT – HRSG	2013	STEAM SILENCER
224	SEDAE ENERTECH CO., LTD.	THE 2'ND PYEONGTAEK CCPP – HRSG	2013	STACK SILENCER
225	SEYANG CORPORATION	UZBEKISTAN, UGCC U&O PROJECT – AIR DRYER	2013	AIR SILENCER
226	SC ENGINEERING CO., LTD.	DEOKYANG HC PROJECT	2013	STEAM SILENCER
227	SUN PLANT ENGINEERING CO., LTD.	POSCO, NEEDLE COKE PLANT	2013	STEAM SILENCER
228	BHI CO., LTD.	POSCOENERGY CCPP UNIT 7,8,9 – HRSG(UNIT 7)	2013	STACK SILENCER
229	SAMYANG TECH CO., LTD.	ANSAN COMBINED HEAT & POWER PLANT – FLASH TANK	2013	STEAM SILENCER
230	HANSHIN BOILER CO., LTD.	IRAQ, AL-AMMARA GAS POWER PLANT	2014	STEAM SILENCER
231	BHI CO., LTD.	LIBYA, ZWITINA COMBINED CYCLE POWER PLANT – HRSG	2014	STEAM SILENCER
232	E-TEC E&C LIMITED	KSA, SABIC GAS, SADARA GAS SUPPLY PROJECT	2014	GAS SILENCER
233	BHI CO., LTD.	CHILE, COCHRANE TPP – BOP PACKAGE	2014	STEAM SILENCER
234	BHI CO., LTD.	POSCOENERGY CCPP UNIT 7,8,9 – HRSG(UNIT 8,9)	2014	STACK SILENCER
235	SAMSHIN ENC CO., LTD.	POSCO, SNG PROJECT	2014	STEAM SILENCER
236	DAEKYUNG MACHINERY & ENGINEERING CO., LTD.	GIM-CHEON COMMUNITY ENERGY PROJECT –AUX. BOILER	2014	STEAM SILENCER
237	GS ENGINEERING & CONSTRUCTION	TAEAN IGCC POWER PLANT (COMBINED CYCLE BLOCK)	2014	STEAM SILENCER
238	SAMSUNG ENGINEERING CO., LTD.	BOLIVIA, YPFB AMMONIA/UREA PROJECT	2014	AIR/GAS SILENCER

NO.	CUSTOMER	PROJECT NAME	YEAR	ITEM NAME
239	SAMSUNG ENGINEERING CO., LTD.	BOLIVIA YPFB AMMONIA/UREA PROJECT	2014	STEAM / AIR / GAS SILENCER
240	DAEKYUNG MACHINERY & ENGINEERING CO., LTD.	COTE D'IVIRE, CIPREL IV VOLET B PROJECT – HRSG	2014	STEAM / STACK SILENCER
241	WELCRON KANGWON CO., LTD.	SHIN-HANUL NUCLEAR POWER PLANT	2014	STEAM SILENCER
242	BHI CO., LTD.	ALGERIA, BISKRA COMBINED CYCLE POWER PLANT – HRSG	2014	STACK SILENCER
243	DAEKYUNG MACHINERY & ENGINEERING CO., LTD.	ALGERIA, AIN ARNAT 1200MW CCPP – HRSG	2014	STEAM SILENCER
244	WELCRON KANGWON CO., LTD.	IRAN, SOUTH PARS GAS FIELD DEVELOPMENT PROJECT(PH.20&21)	2014	STEAM SILENCER
245	SAMSUNG ENGINEERING CO., LTD.	KSA, ARAMCO, LUBEREF YANBU REFINERY EXPANSION PROJECT	2014	STEAM / GAS SILENCER
246	THE BAHRAIN PETROLEUM COMPANY B.S.C	INCREASE 24CI STRIPPING STEAM VENTSIZEAND PROVIDE SILENCER AT 4A CDU	2014	STEAM SILENCER
247	SAMSUNG C&T CORPORATION	MALAYSIA, PRAI CCGT POWER PROJECT	2014	STEAM SILENCER
248	SEDAE ENERTECH CO., LTD.	GS EPS, DANGJIN 4 BIOMASS POWER PLANT	2014	STEAM SILENCER
249	HANKOOK B&TEC CO., LTD.	BUKPYEONG THERMAL POWER PLANT – AUX. BOILER	2014	STEAM SILENCER
250	SEDAE ENERTECH CO., LTD.	THAILAND, THAI BINH 2 THERMAL POWER PLANT 2 x 600MW	2014	STEAM SILENCER
251	HYUNDAI ENGINEERING CO., LTD.	INDONESIA, ASC PHASE-VI (INAS) PROJECT	2014	STEAM SILENCER
252	HANSHIN BOILER CO., LTD.	CHEON-AN MUNICIPAL SOLID WASTE BTO PROJECT	2014	STEAM SILENCER
253	HANSOL SEENTEC CO., LTD.	WONJU RDF COGENERATION PLANT	2014	STEAM SILENCER
254	SAMSUNG TOTAL PETRO-CHEMICALS CO., LTD.	DAESAN PLANT, UNIT17 PELLET HANDLING DRYER PROJECT	2014	AIR SILENCER
255	SEYANG CORPORATION	THAILAND, LINEAR ALKYL BENZEN PROJECT – AIR DRYER	2014	AIR SILENCER
256	HANWHA ENERGY CORPORATION	YEOSU PLANT BACK PRESSURE TURBINE PROJECT	2014	STEAM SILENCER
257	SAMSUNG ENGINEERING CO., LTD.	KSA, ARAMCO, LUBEREF YANBU REFINERY EXPANSION PROJECT(2'ND)	2014	STEAM / GAS SILENCER
258	HYOSUNG CORPORATION	DH-2 PROJECT	2014	STEAM SILENCER
259	SEYANG CORPORATION	IRAQ, EPC CPF FOR AKKAS GAS FIELD PROJECT – AIR DRYER	2015	AIR SILENCER
260	JUNGHO E&C CO., LTD.	SAM CHEOK GREEN POWER PLANT UNIT 1&2	2015	STEAM SILENCER
261	SAMSUNG ENGINEERING CO., LTD.	BOLIVIA, YPFB AMMONIA/UREA PROJECT(2'ND)	2015	STEAM / AIR / GAS SILENCER
262	HANSOL SEENTEC CO., LTD.	UAE, BARAKAH NUCLEAR POWER PLANT (UNIT #1,2)	2015	STEAM SILENCER

NO.	CUSTOMER	PROJECT NAME	YEAR	ITEM NAME
263	WELCRON KANGWON CO., LTD.	ULSAN, SK PDH PROJECT	2015	STEAM SILENCER
264	DAELIM INDUSTRIAL CO., LTD.	KSA, UMM WU'AL EPC PROJECT – AMMONIA PLANT	2015	STEAM / AIR / GAS SILENCER
265	SEDAE ENERTECH CO., LTD.	OSAN COMBINED HEAT AND POWER PROJECT – HRSG	2015	STEAM / STACK SILENCER
266	DAELIM INDUSTRIAL CO., LTD.	KSA, SHOAIBA II CCPP – DEAERATOR	2015	STEAM SILENCER
267	SAMSHIN ENC CO., LTD.	SINGAPORE, SEMBCORP EFW (Energy-from-Waste) PROJECT	2015	STEAM SILENCER
268	DAELIM INDUSTRIAL CO., LTD.	PHILLIPINES, SM 200 POWER STATION	2015	STEAM SILENCER
269	BHI CO., LTD.	SEAGULL(GE4) CFBC BOILER PROJECT	2015	STEAM SILENCER
270	SAMSUNG ENGINEERING CO., LTD.	CHILE, KELAR CCPP	2015	STEAM SILENCER
271	J TECH CO., LTD.	KSA, RABIGH II IPP	2015	STEAM SILENCER
272	SPIRAXSARCO CO., LTD.	GUNSAN OCI P2 STEAM GENERATION SYSTEM PROJECT	2015	STEAM SILENCER
273	E-TEC E&C LIMITED	SEAGULL(GE4) CFBC BOILER PROJECT	2015	STEAM SILENCER & DUCT
274	WELCRON KANGWON CO., LTD.	TURKMENISTAN, TACE ETHANE CRACKER AND PE/PP PLANT	2015	STEAM SILENCER
275	SEONGHWA INDUSTRIES CO., LTD.	DANGJIN 4 CCPP	2015	STEAM SILENCER
276	POWER HX TECH CO., LTD.	HYUNDAI OILBANK, NEW FBC BOILER PROJECT (#10)	2015	STEAM SILENCER
277	HANSOL SEENTEC CO., LTD.	SEOKMUN BIO-SRF COMBINED HEAT & POWER PLANT	2015	STEAM SILENCER
278	DAEWOO E&C CO., LTD.	POCHEON CCPP – UNIT #1 – AUX. BOILER	2015	STEAM SILENCER
279	BHI CO., LTD.	USA, CALPINE YORK 2 PROJECT – HRSG	2015	STEAM / STACK SILENCER
280	DAEKYUNG MACHINERY & ENGINEERING CO., LTD.	JAPAN, IHI MCN PROJECT – HRSG	2015	STEAM / STACK SILENCER
281	SEONGHWA INDUSTRIES CO., LTD.	WIRYE COMBINED HEAT & POWER PLANT	2016	STEAM SILENCER
282	HANSOL SEENTEC CO., LTD.	KSA, YANBU POWER AND DESALINATION PLANT – PHASE 3	2016	STEAM SILENCER
283	WELCRON KANGWON CO., LTD.	UZBEKISTAN, MKAN PROJECT (KANDYM GAS PROCESSING COMPLEX)	2016	STEAM SILENCER
284	SPX FT KOREA	UAE, SARB #4 FIELD DEVELOPMENT PROJECT	2016	AIR SILENCER
285	HYUNDAI ENGINEERING & CONSTRUCTION CO., LTD.	UZBEKISTAN, TALIMARJAN THERMAL POWER PLANT EXPANSION PROJECT	2016	STEAM SILENCER
286	WELCRON KANGWON CO., LTD.	MOROCCO, SAFI INDEPENDENT POWER PROJECT	2016	STEAM SILENCER

NO.	CUSTOMER	PROJECT NAME	YEAR	ITEM NAME
287	SAMKWANG POWER SYSTEM CORPORATION	KSA, QASSIM EXTENSION II & III TO COMBINED CYCLE PLANT	2016	STEAM SILENCER
288	SPX FT KOREA	UAE, UMM LULU PHASE II FULL FIELD DEVELOPMENT PROJECT	2016	AIR SILENCER
289	J TECH CO., LTD. / SAMSUNG C&T	QATAR, FACILITY D – IWPP	2016	STEAM SILENCER
290	BHI CO., LTD.	EGYPT, SOUTH HELWAN SUPERCRITICAL POWER PLANT	2016	STEAM SILENCER
291	SEYANG CORPORATION	IRAQ, KARBALA REFINERY PROJECT (1038, 7030 UNIT)– AIR DRYER	2016	AIR SILENCER
292	DAEKYUNG MACHINERY & ENGINEERING CO., LTD.	THAILAND, ROJANA POWER SPP 3 PROJECT – HRSG	2016	STEAM SILENCER
293	DAEWOO E&C CO., LTD.	YOUNGNAM COMBINED CYCLE POWER PLANT	2016	STEAM SILENCER
294	HANWHA CHEMICAL CO., LTD.	OXY 5 EXPANSION PROJECT	2016	STEAM SILENCER
295	DAEWOO E&C CO., LTD.	ALGERIA, CENTRAL COMBINED CYCLE RAS DJINET 3 X 400 MW	2016	STEAM SILENCER
296	DAEWOO E&C CO., LTD.	MOROCCO, SAFI INDEPENDENT POWER PROJECT	2016	STEAM SILENCER
297	DAEKYUNG MACHINERY & ENGINEERING CO., LTD.	GS E&C, POCHON CHPP – AUX. BOILER	2016	STEAM SILENCER
298	SAMSUNG C&T CORPORATION	TURKEY, KIRIKKALE INDEPENDENT POWER PROJECT	2016	STEAM SILENCER
299	HYOSUNG CORPORATION	PP3 PROJECT	2016	GAS SILENCER
300	HANHWA TOTAL PETROCHEMICAL CO.,LTD.	SCC NO.2 UTILITY / OFFSITE PROJECT	2016	STEAM SILENCER
301	GS ENGINEERING & CONSTRUCTION	TAEAN IGCC POWER PLANT (COMBINED CYCLE BLOCK, 2'ND)	2016	STEAM SILENCER
302	DAELIM INDUSTRIAL CO., LTD.	VIETNAM, THAI BINH 2 THERMAL POWER PLANT 2 x 600MW	2016	STEAM SILENCER
303	SAMSUNG ENGINEERING CO., LTD.	BOLIVIA, YPFB AMMONIA/UREA PROJECT(2'ND)	2016	AIR SILENCER
304	HYUNDAI ENGINEERING CO., LTD.	LOTTE VERSAILS SPECIAL RUBBERS PROJECT	2016	STEAM SILENCER
305	HANSHIN B-TEC CORP.	HWASEONG DONGTAN2 CHP – AUX. BOILER	2016	STEAM SILENCER
306	HYUNDAI ENGINEERING CO., LTD.	PHILIPPINES, THERMA VISAYAS ENERGY PROJECT	2016	STEAM SILENCER
307	DAEKYUNG MACHINERY & ENGINEERING CO., LTD.	TANZANIA, KINYEREZI II 240MW CCPP – HRSG	2016	STEAM / STACK SILENCER
308	E-TEC E&C LIMITED	KSA, SAFCO IV RELIABILITY IMPROVEMENT PROJECT	2017	STEAM / GAS SILENCER
309	HANSOL SEENTEC CO., LTD.	UAE, BARAKAH NUCLEAR POWER PLANT (UNIT #3,4)	2017	STEAM SILENCER
310	WELCRON KANGWON CO., LTD.	TRINIDAD, TMD PROJECT	2017	STEAM SILENCER

NO.	CUSTOMER	PROJECT NAME	YEAR	ITEM NAME
311	HANSOL SEENTEC CO., LTD.	POSEUNG BIOMASS COGENERATION PLANT	2017	STEAM SILENCER
312	HYUNDAI ENGINEERING CO., LTD.	OMAN, MUSANDAM GAS POWER PLANT	2017	STEAM SILENCER
313	SAMSUNG ENGINEERING CO., LTD.	USA, LA MEG-1 PROJECT	2017	STEAM SILENCER
314	WELCRON KANGWON CO., LTD.	VIETNAM, SONG HAU 1 THERMAL POWER PLANT(2x600MW).	2017	STEAM SILENCER
315	DAEKYUNG MACHINERY & ENGINEERING CO., LTD.	TANZANIA, KINYEREZI II 240MW CCPP - HRSG(2'ND)	2017	STEAM / STACK SILENCER
316	E-TEC E&C LIMITED	KSA, SAFCO IV RELIABILITY IMPROVEMENT PROJECT(2'ND)	2017	STEAM / GAS SILENCER
317	KOREA ENERGY INDUSTRIES CO., LTD	GS E&C, ANYANG CHP PLANT	2017	STEAM SILENCER
318	DAEYEO BOILER CO.,LTD.	DS POWER, OSAN CHP PROJECT	2017	STEAM SILENCER
319	HANSOL SEENTEC CO., LTD.	GS POCHEON CHP PLANT	2017	STEAM SILENCER
320	SK ENGINEERING & CONSTRUCTION CO., LTD.	WIRYE COMBINED HEAT & POWER PLANT	2017	GAS SILENCER
321	WELCRON KANGWON CO., LTD.	POSEUNG BIOMASS COGENERATION PLANT	2017	STEAM SILENCER
322	DAEWOO E&C CO., LTD.	S-OIL, RESIDUE UPGRADING COMPLEX PROJECT(Area3)	2017	STEAM/GAS SILENCER
323	DAEWOO E&C CO., LTD.	YOUNGNAM COMBINED CYCLE POWER PLANT	2017	STEAM SILENCER
324	DAELIM INDUSTRIAL CO., LTD.	S-OIL, RESIDUE UPGRADING COMPLEX PROJECT(D4)	2017	STEAM/GAS SILENCER
325	WELCRON KANGWON CO., LTD.	KAZAKHSTAN, PKOP REFINERY MODERNIZATION & REVAMPING PROJECT	2017	STEAM SILENCER
326	DAEWOO E&C CO., LTD.	S-OIL, RESIDUE UPGRADING COMPLEX PROJECT(W2,W4)	2017	STEAM/GAS SILENCER
327	WELCRON KANGWON CO., LTD.	S-OIL, RESIDUE UPGRADING COMPLEX PROJECT	2017	STEAM/GAS SILENCER
328	E TEC E&C LIMITED	KSA, IMC EXPANSION PROJECT	2017	STEAM SILENCER
329	SUN PLANT ENGINEERING CO., LTD.	500 MW (GROSS) SUPERCRITICAL PULVERIZED COAL-FIRED POWER PLANT	2017	STEAM SILENCER
330	HI-TECH Engineering Co., Ltd.	Y2 REVAMP(CO2 RECYCLE) PROJECT	2017	STEAM SILENCER
331	SPIRAXSARCO CO., LTD.	DAESAN HOC Project	2017	STEAM SILENCER
332	HANHWA TOTAL PETROCHEMICAL CO.,LTD.	U-1SL12;HS#3 START-UP VENT SILENCER	2017	STEAM SILENCER
333	SEYANG CORPORATION	KARBALA REFINERY PROJECT (4035 UNIT)	2017	STEAM SILENCER
334	JGC PHILIPPINES, INC	SEC210-1X105MW COAL FIRED POWER PROJECT	2017	STEAM SILENCER

SILENCER EXPERIENCE LIST (MIDDLE EAST)

No.	PROJECT NAME	EQUIPMENT	CUSTOMER	CLIENT/EMPLOYER	LOCATION	YEAR
1	LAFFAN REFINERY PROJECT	STEAM SILENCER	KANGWON B&E CO., LTD.	LAFFAN REFINERY COMPANY	RAS LAFFAN, STATE OF QATAR	2006
2	ZAWIA COMBINED CYCLE POWER PLANT	STEAM SILENCER	KANGWON B&E CO., LTD. (HDEC)	GENERAL ELECTRIC COMPANY OF LIBYA (GECOL)	TRIPOLI, LIBYA	2006
3	SAUDI, APPC PDH/PP PROJECT	STEAM/AIR SILENCER	SAMSUNG ENGINEERING CO., LTD.	ADVANCED POLYPROPYLENE COMPANY(APPC)	AL-JUBAIL, SAUDI ARABIA	2007
4	SOUTH PARS GAS FIELD DEVELOPMENT PHASE 9 & 10	AIR SILENCER	KANGWON B&E CO., LTD.	PARS OIL AND GAS COMPANY	ASSALUYEH, IRAN	2007
5	AL SHUWEIHAT S2 IWPP PROJECT	STEAM SILENCER	BHI CO., LTD.	M/S. RUWAIS SUEZ TRACTEBEL POWER COMPANY	ABU-DHABI, UAE	2008
6	MA'ADEN AMMONIA PROJECT	STEAM SILENCER	SAMSUNG ENGINEERING CO., LTD.	SAUDI ARABIA MINING COMPANY (MA'ADEN)	RAS AZ ZAWR, SAUDI ARABIA	2008
7	SHUAIBAH III IWPP POWER PLANT	STEAM SILENCER	SEONGHWA INDUSTRIES CO., LTD. / DOOSAN HEAVY IND. CO., LTD.	SHUAIBAH WATER & ELECTRICITY COMPANY	SHUAIBAH, SAUDI ARABIA	2008
8	BOROUGE 2 OCU PROJECT	STEAM SILENCER	SAMSUNG ENGINEERING CO., LTD.	ABU DHABI POLYMERS COMPANY (BOROUGE)	RUWAIS, UAE	2008
9	MA'ADEN PHOSPHATE PROJECT, POWER & DESALINATION PLANT	STEAM SILENCER	HANWHA ENGINEERING & CONSTRUCTION	MA'ADEN PHOSPHATE COMPANY	AL-JUBAIL, SAUDI ARABIA	2009
10	RAS LAFFAN C IWPP PROJECT	STEAM SILENCER	WOORYANG HC CO., LTD. / HDEC	RAS GIRTAS POWER COMPANY	RAS LAFFAN, QATAR	2009
11	LUBE BASE OIL PLANT(LBOP) PROJECT	STEAM SILENCER	SAMSUNG ENGINEERING CO., LTD.	THE BAHRAIN PETROLEUM COMPANY B.S.C. ©	SITRAH, BAHRAIN	2009
12	MA'ADEN PHOSPHATE PROJECT, POWER & DESALINATION PLANT(2'ND)	STEAM SILENCER	HANWHA ENGINEERING & CONSTRUCTION	MA'ADEN PHOSPHATE COMPANY	AL-JUBAIL, SAUDI ARABIA	2009
13	MA'ADEN AMMONIA PROJECT(2'ND)	STEAM/GAS SILENCER	SAMSUNG ENGINEERING CO., LTD.	SAUDI ARABIA MINING COMPANY (MA'ADEN)	RAS AZ ZAWR, SAUDI ARABIA	2009
14	ARZEW REFINERY PROJECT	STEAM SILENCER	WOORYANG HC CO., LTD.	NAFTAC SPA	ARZEW, ALGERIA	2010
15	ABU-QIR THERMAL POWER PLANT 6&7 (650MWx2)	STEAM SILENCER	BHI CO., LTD.	DELTA ELECTRICITY PRODUCTION COMPANY	ABU-QIR, EGYPT	2010
16	SAUDI, ARAMCO RAS TANURA REFINERY DIESEL HYDROTREATER COMPLEX PROJECT	STEAM SILENCER	SAMSUNG ENGINEERING CO., LTD.	SAUDI ARABIA OIL COMPANY (SAUDI, ARAMCO)	RAS TANURA, SAUDI ARABIA	2010
17	JUBAIL EXPORT REFINERY PROJECT PKG #3 AROMATICS UNITS	STEAM SILENCER	SAMSUNG ENGINEERING CO., LTD.	SAUDI ARAMCO TOTAL REFINING & PETROCHEMICAL COMPANY	AL-JUBAIL, SAUDI ARABIA	2010

SILENCER EXPERIENCE LIST (MIDDLE EAST)

No.	PROJECT NAME	EQUIPMENT	CUSTOMER	CLIENT/EMPLOYER	LOCATION	YEAR
18	PETROTRIN, ULTRA LOW SULPHUR DIESEL UNIT PROJECT	STEAM SILENCER	SAMSUNG ENGINEERING CO., LTD.	PETROLEUM COMPANY OF TRINIDAD AND TOBAGO LIMITED	POINTE-A-PIERRE, TRINIDAD & TOBAGO	2011
19	SABIC, GAS JUBAIL PHASE-VIII PROJECT	GAS/STEAM SILENCER	SAMSUNG ENGINEERING CO., LTD.	NATIONAL INDUSTRIAL GASES COMPANY (GAS)	AL-JUBAIL, SAUDI ARABIA	2011
20	KAVEH METHANOL PLANT PROJECT (7,000MTPD)	STEAM SILENCER	KANGWON B&E CO., LTD.	KAVEH GLASS INDUSTRY GROUP	KAVEH, IRAN	2011
21	FERTIL-2 AMMONIA/UREA EXPANSION PROJECT	STEAM/GAS SILENCER	SAMSUNG ENGINEERING CO., LTD.	RUWAIS FERTILIZER INDUSTRIES (FERTIL)	ABU-DHABI, UAE	2011
22	SOHAR 2 INDEPENDENT POWER PLANT	STEAM SILENCER	KANGWON B&E CO., LTD. (SIEMENS, GS E&C)	SOHAR POWER COMPANY	SOHAR, OMAN	2011
23	SAUDI, SAMCO ACRYLIC ACID PROJECT	STEAM SILENCER	SAMSUNG ENGINEERING CO., LTD.	SAUDI ACRYLIC MONOMER COMPANY	AL JUBAIL, SAUDI ARABIA	2011
24	SKIKDA REFINERY PROJECT	STEAM SILENCER	SAMSUNG ENGINEERING CO., LTD.	SONATRACH ACTIVITE AVAL-DIVISION RAFFINAGE	SKIKDA, ALGERIA	2011
25	BARKA 3 INDEPENDENT POWER PLANT	STEAM SILENCER	KANGWON B&E CO., LTD. (SIEMENS, GS E&C)	AL SUWADI POWER COMPANY SAOC SULTANATE OF OMAN	BARKA, OMAN	2011
26	UAE, SHAH GAS DEVELOPMENT PKG.4 U&O	STEAM SILENCER	SAMSUNG ENGINEERING CO., LTD.	ABU DHABI NATIONAL OIL COMPANY (ADNOC)	SHAH GAS FIELD, UAE	2011
27	MA'ADEN AMMONIA PROJECT(3'RD)	GAS SILENCER	SAMSUNG ENGINEERING CO., LTD.	MA'ADEN (SAUDI ARABIAN MINING COMPANY)	AL JUBAIL, SAUDI ARABIA	2011
28	FERTIL EXPANSION PROJECT (FERTIL-2)	STEAM SILENCER	SAMSUNG ENGINEERING CO., LTD.	RUWAIS FERTILIZER INDUSTRIES (FERTIL)	RUWAIS, UAE	2012
29	YANBU2 POWER AND WATER PROJECT	STEAM SILENCER	DAEKYUNG MACHINERY & ENGINEERING CO., LTD.	MARAFIQ	AL JUBAIL, SAUDI ARABIA	2012
30	MOROCCO, JORF LASFAR UNIT 5&6 PROJECT	STEAM SILENCER	SVC INC.	JORF LASFAR ENERGY COMPANY (JLEC)	CASABLANCA, MOROCCO	2012
31	OMAN, MUSANDAM GAS PLANT PROJECT	STEAM SILENCER	HANKOOK B&TEC CO., LTD.	OMAN OIL COMPANY EXPLORATION & PRODUCTION LLC	MUSANDAM, OMAN	2012
32	KAVEH SODA PLANT PROJECT	STEAM SILENCER	KANGWON B&E CO., LTD.	KAVEH GLASS INDUSTRY GROUP	KAVEH, IRAN	2012
33	YANBU2 POWER AND WATER PROJECT	STEAM SILENCER	HANWHA ENGINEERING & CONSTRUCTION	MARAFIQ	AL JUBAIL, SAUDI ARABIA	2012
34	BAHRAIN, MUHARRAQ STP AND SEWER CONVEYANCE SYSTEM	STEAM SILENCER	SAMSUNG ENGINEERING CO., LTD. / DONGBO HEAVY IND. CO., LTD.	MUHARRAQ STP Company BSC(c)	MUHARRAQ, BAHRAIN	2012

SILENCER EXPERIENCE LIST (MIDDLE EAST)

No.	PROJECT NAME	EQUIPMENT	CUSTOMER	CLIENT/EMPLOYER	LOCATION	YEAR
35	BOROUGE 3 UTILITIES & OFFSITES PROJECT	STEAM SILENCER	HYUNDAI ENGINEERING & CONSTRUCTION CO., LTD.	ABU DHABI POLYMERS COMPANY (BOROUGE)	RUWAIS, UAE	2012
36	SHAYBAH NGL#2 RECOVERY & UTILITIES PROJECT	STEAM SILENCER	SAMSUNG ENGINEERING CO., LTD.	SAUDI ARABIA OIL COMPANY (SAUDI, ARAMCO)	AL JUBAIL, SAUDI ARABIA	2012
37	OMAN, MUSANDAM GAS PLANT PROJECT	STEAM SILENCER	HYUNDAI ENGINEERING & CONSTRUCTION CO., LTD.	OMAN OIL COMPANY EXPLORATION & PRODUCTION LLC	MUSANDAM, OMAN	2012
38	SHAYBAH #2, #4 RECOVERY & UTILITIES PROJECT	AIR SILENCER	SPX FLOW TECHNOLOGY KOREA CO., LTD.	SAUDI ARABIA OIL COMPANY (SAUDI, ARAMCO)	AL JUBAIL, SAUDI ARABIA	2012
39	MA'ADEN ALUMINA REFINERY STEAM PLANT PROJECT	STEAM SILENCER	SAMSUNG ENGINEERING CO., LTD.	MA'ADEN BAUXITE AND ALUMINA COMPANY	AL JUBAIL, SAUDI ARABIA	2013
40	YANBU2 POWER AND WATER PROJECT (2'ND, MED)	STEAM SILENCER	HANWHA ENGINEERING & CONSTRUCTION	MARAFIQ	AL JUBAIL, SAUDI ARABIA	2013
41	SHOAIBA II COMBINED CYCLE POWER PLANT	STEAM SILENCER	DAELIM INDUSTRIAL CO., LTD.	SAUDI ELECTRICITY COMPANY (SAUDI, SEC)	SHOAIBA, SAUDI ARABIA	2013
42	QURAYYAH INDEPENDENT POWER PLANT	STEAM SILENCER	J TECH CO., LTD. / SAMSUNG C&T CORPORATION	HAJR ELECTRICITY PRODUCTION COMPANY	QURAYYAH, SAUDI ARABIA	2013
43	WASIT #2 COGENERATION & STEAM GENERATION PROJECT	STEAM SILENCER	SAMSUNG ENGINEERING CO., LTD.	SAUDI ARABIA OIL COMPANY (SAUDI, ARAMCO)	AL JUBAIL, SAUDI ARABIA	2013
44	AL-AMMARA GAS TURBINES POWER PLANT	STEAM SILENCER	HANSHIN BOILER CO., LTD. / STX HEAVY INDUSTRIES CO., LTD.	REPUBLIC OF IRAQ MINISTRY OF ELECTRICITY	AL-AMMARA, IRAQ	2014
45	SADARA GAS SUPPLY PROJECT	GAS SILENCER	E TEC E&C LIMITED	NATIONAL INDUSTRIAL GASES COMPANY (GAS)	AL-JUBAIL, SAUDI ARABIA	2014
46	LUBEREF YANBU REFINERY EXPANSION PROJECT	STEAM SILENCER	SAMSUNG ENGINEERING CO., LTD.	SAUDI ARAMCO LUBRICATING OIL REFINING COMPANY	YANBU, SAUDI ARABIA	2014
47	SOUTH PARS GAS FIELD DEVELOPMENT PHASE 20 & 21	AIR SILENCER	KANGWON B&E CO., LTD.	PARS OIL AND GAS COMPANY	ASSALUYEH, IRAN	2014
48	INCREASE 24CI STRIPPING STEAM VENT SIZE AND PROVIDE SILENCER AT 4A CDU	STEAM SILENCER	THE BAHRAIN PETROLEUM COMPANY B.S.C	THE BAHRAIN PETROLEUM COMPANY B.S.C	BAHRAIN	2014
49	LUBEREF YANBU REFINERY EXPANSION PROJECT (2ND)	STEAM SILENCER	SAMSUNG ENGINEERING CO., LTD.	SAUDI ARAMCO LUBRICATING OIL REFINING COMPANY	YANBU, SAUDI ARABIA	2014
50	EPC CPF FOR AKKAS GAS FIELD PROJECT	AIR SILENCER	SEYANG CORPORATION / DAEWOO E & C CO., LTD.	KOGAS AKKAS B. V.	ANBAR, IRAQ	2015
51	BARAKAH NUCLEAR POWER PLANT UNIT #1,2	STEAM SILENCER	HANSOL SEENTEC CO., LTD. / KOREA ELECTRIC POWER CO. (KEPCO)	EMIRATES NUCLEAR ENERGY CORPORATION	BARAKAH, UAE	2015

SILENCER EXPERIENCE LIST (MIDDLE EAST)

No.	PROJECT NAME	EQUIPMENT	CUSTOMER	CLIENT/EMPLOYER	LOCATION	YEAR
52	UMM WU'AL EPC PROJECT - AMMONIA PLANT	STEAM/AIR/GAS SILENCER	DAELIM INDUSTRIAL CO., LTD.	SAUDI ARABIA MINING COMPANY (MA'ADEN)	RAS AL KHAIR, SAUDI ARABIA	2015
53	RABIGH II INDEPENDENT POWER PLANT	STEAM SILENCER	J TECH CO., LTD. / SAMSUNG C&T CORPORATION	AL-MOURJAN FOR ELECTRICITY PRODUCTION COMPANY	RABIGH, SAUDI ARABIA	2015
54	SHOAIBA II CCPP - DEAERATOR	STEAM SILENCER	DAELIM INDUSTRIAL CO., LTD.	SAUDI ELECTRICITY COMPANY (SAUDI, SEC)	SHOAIBA, SAUDI ARABIA	2015
55	YANBU POWER AND DESALINATION PLANT - PHASE 3	STEAM SILENCER	HANSOL SEENTEC CO., LTD. / DOOSAN HEAVY IND. & CONST. CO., LTD.	SALINE WATER CONVERSION CORPORATION(SWCC)	YANBU, SAUDI ARABIA	2016
56	SARB #4 FIELD DEVELOPMENT PROJECT	AIR SILENCER	SPX FLOW TECHNOLOGY KOREA CO., LTD. / HYUNDAI E & C CO., LTD.	ABU DHABI MARINE OPERATING COMPANY	ABU DHABI, UAE	2016
57	QATAR FACILITY D - IWPP	STEAM SILENCER	J TECH CO., LTD. / SAMSUNG C&T CORPORATION	UMM AL HOUL POWER	DOHA, QATAR	2016
58	UMM LULU PHASE II FULL FIELD DEVELOPMENT PROJECT	AIR SILENCER	SPX FLOW TECHNOLOGY KOREA CO., LTD. / SAMSUNG TECHWIN CO., LTD.	ABU DHABI MARINE OPERATING COMPANY	ABU DHABI, UAE	2016
59	KARBALA REFINERY PROJECT (1038 & 7030 UNIT)	AIR SILENCER	SEYANG CORPORATION / HDGSK JV	IRAQ'S STATE COMPANY FOR OIL PROJECTS(SCOP)	KARBALA, IRAQ	2016
60	QASSIM EXTENSION II & III TO COMBINED CYCLE PLANT	STEAM SILENCER	SAMKWANG POWER SYSTEM CORP. / ENERGYEN CORPORATION	SAUDI ELECTRICITY COMPANY (SAUDI, SEC)	QASSIM, SAUDI ARABIA	2016
61	BARAKAH NUCLEAR POWER PLANT UNIT #3,4	STEAM SILENCER	HANSOL SEENTEC CO., LTD. / KOREA ELECTRIC POWER CO. (KEPCO)	EMIRATES NUCLEAR ENERGY CORPORATION	BARAKAH, UAE	2017
62	SAFCO IV RELIABILITY IMPROVEMENT PROJECT	STEAM/GAS SILENCER	E TEC E&C LIMITED	SAFCO / SABIC	AL JUBAIL, SAUDI ARABIA	2017
62	OMAN, MUSANDAM GAS POWER PLANT	STEAM SILENCER	HYUNDAI ENGINEERING & CONSTRUCTION CO., LTD.	OMAN OIL COMPANY EXPLORATION & PRODUCTION LLC	MUSANDAM, OMAN	2017
63	IMC EXPANSION PROJECT	STEAM SILENCER	E TEC E&C LIMITED	INTERNATIONAL METHANOL COMPANY (IMC)	AL JUBAIL, SAUDI ARABIA	2017
64	KUWAIT, KNPC AL-ZOUR REFINERY PROJECT	STEAM/GAS SILENCER	FDH JV.	KNPC (Kuwait National Petroleum Company)	SHUAIBA, KUWAIT	UNDER WORK

SILENCER EXPERIENCE LIST (KEPCO)

Date : Jan, 15, 2018

No.	PROJECT NAME	EQUIPMENT	CUSTOMER	CLIENT/EMPLOYER	LOCATION	YEAR
1	YEONGHEUNG THERMAL POWER PLANT UNIT 5&6 (870MW x 2)	STEAM SILENCER	DONGBO HEAVY IND. CO., LTD.	KOREA SOUTH-EAST POWER CO., LTD. (KOSEP)	YEONGHEUNG, KOREA	2012
2	ANDONG CCPP PROJECT - HRSG	STEAM/STACK SILENCER	BHI CO., LTD.	KOREA SOUTH POWER CO., LTD. (KOSPO)	ANDONG, KOREA	2013
3	ULSAN #4 COMBINED CYCLE POWER PLANT - HRSG	STEAM SILENCER	SEDAE ENERTECH CO., LTD.	KOREA EAST-WEST POWER CO., LTD. (KOEWP)	ULSAN, KOREA	2013
4	ANSAN COMBINED HEAT & POWER PLANT - FLASH TANK	STEAM SILENCER	SAMYANG TECH CO., LTD.	KOREA SOUTH-EAST POWER CO., LTD. (KOSEP)	ANSAN, KOREA	2013
5	SAM CHEOK GREEN POWER PLANT UNIT 1&2-AUX. BOILER	STEAM SILENCER	HANKOOK B&TEC CO., LTD.	KOREA SOUTH POWER CO., LTD. (KOSPO)	SAMCHEOK, KOREA	2013
6	ANDONG CCPP PROJECT - AUX. BOILER	STEAM SILENCER	HANSHIN BOILER CO., LTD.	KOREA SOUTH POWER CO., LTD. (KOSPO)	ANDONG, KOREA	2013
7	THE 2'ND PYEONGTAEK COMBINED CYCLE POWER PLANT-HRSG	STACK SILENCER	SEDAE ENERTECH CO., LTD.	KOREA WESTERN POWER CO., LTD. (KOWEPO)	PYEONGTAEK, KOREA	2013
8	HADONG POWER PLANT - 10MW CCS PROJECT	STEAM SILENCER	KC COTTRELL CO., LTD.	KOREA SOUTH POWER CO., LTD. (KOSPO)	HADONG, KOREA	2013
9	ULSAN OIL-FIRED & C.C POWER COMPLEX FUEL CELL SYSTEM	STEAM SILENCER	HANSHIN ENGINEERING CO., LTD. / POSCO ENERGY	KOREA EAST-WEST POWER CO., LTD. (KOEWP)	ULSAN, KOREA	2013
10	TAEAN IGCC POWER PLANT (COMBINE CYCLE BLOCK, 300MWx1UNIT)	STEAM SILENCER	GS ENGINEERING & CONSTRUCTION	KOREA WESTERN POWER CO., LTD. (KOWEPO)	TAEAN, KOREA	2014
11	SHIN-HANUL NUCLEAR POWER PLANT - AUX. BOILER	STEAM SILENCER	WELCRON KANGWON CO., LTD.	KOREA HYDRO & NUCLEAR POWER CO., LTD. (KHNP)	SHIN-ULJIN, KOREA	2014
12	WONJU RDF COGENERATION PLANT UNIT 1(10MW x 1)	STEAM SILENCER	HANSOL SEENTEC CO., LTD.	KOREA MIDLAND POWER CO., LTD. (KOMIPO)	WONJU , KOREA	2014
13	SAM CHEOK GREEN POWER PLANT UNIT 1&2	STEAM SILENCER	DAEWOO E & C CO., LTD. / JUNGHO E & C CO., LTD.	KOREA SOUTH POWER CO., LTD. (KOSPO)	SAMCHEOK, KOREA	2014
14	BARAKAH NUCLEAR POWER PLANT UNIT #1,2	STEAM SILENCER	HANSOL SEENTEC CO., LTD. / KOREA ELECTRIC POWER CO.	EMIRATES NUCLEAR ENERGY CORPORATION	BARAKAH, UAE	2015
15	OSAN COMBINED HEAT & POWER PLANT - HRSG	STEAM/STACK SILENCER	SEDAE ENERTECH CO., LTD.	KEPCO E&C CO., INC. / DSPower	OSAN, KOREA	2015
16	YOUNGNAM COMBINED CYCLE POWER PLANT	STEAM SILENCER	DAEWOO E & C CO., LTD.	KOREA SOUTH POWER CO., LTD. (KOSPO)	ULSAN, KOREA	2016
17	TAEAN IGCC POWER PLANT (COMBINE CYCLE BLOCK, 300MWx1UNIT)	STEAM SILENCER	GS ENGINEERING & CONSTRUCTION	KOREA WESTERN POWER CO., LTD. (KOWEPO)	TAEAN, KOREA	2016



MAJOR REFERENCE LIST (PHOTO SCENE)

MAJOR REFERENCE LIST(PHOTO SCENE)

1. APPC PDH/PP Project, Saudi Arabia : Shipping Scene

<Steam Silencer- 305 Ton/Hr>



2. APPC PDH/PP Project, Saudi Arabia : Shipping Scene

<Air Silencer – 544 Ton/Hr & Steam silencer- 50 Ton/Hr>



MAJOR REFERENCE LIST(PHOTO SCENE)

3. ONGKHLA CCPP Project, Thailand : Shipping Scene

<Steam Silencer- 360 Ton/Hr>



4. HENC, Gun Jang Co-Gen. Project, Korea : Packing Scene

<Steam Silencer - 50 Ton/Hr>



MAJOR REFERENCE LIST(PHOTO SCENE)

5. Posco, Heavy Plate Capacity Reinforcement Project, Korea : Packing Scene
<Steam Silencer- 426 Ton/Hr>



6. Shin-Kori Nuclear Power Plant 1&2 Project, Korea : Packing Scene
<Steam Silencer - 68 Ton/Hr>



MAJOR REFERENCE LIST(PHOTO SCENE)

7. AN & MMA Plant Project, Thailand : Shipping Scene

<Steam Silencer– 170 Ton/Hr>



8. HENC, Ma'aden Phosphate Project, Saudi Arabia : Packing Scene

<Steam Silencer – 282 Ton/Hr>



MAJOR REFERENCE LIST(PHOTO SCENE)

9. SECL, Ma'aden Ammonia Project, Saudi Arabia : Packing Scene

<Steam Silencer– 130 Ton/Hr>



10. SC-2158, MA'ADEN AMMONIA PROJECT, Saudi Arabia : Packing Scene

<Air Intake Silencer – 282 Ton/Hr>



MAJOR REFERENCE LIST(PHOTO SCENE)

11. Posco Power CCPP Unit 5&6 (500MW x 2), Korea : Packing Scene

<Steam Silencer- 230(260/46/35/10)Ton/Hr, 16sets>



12. Al Shuweihat S2 IWPP Project, U.A.E : Packing Scene

<Steam Silencer - 282 Ton/Hr>



MAJOR REFERENCE LIST(PHOTO SCENE)

13.Aramco, Jubail Export Refiney Project – PKG #3 Aromatics Units

Jubail, Kingdom of Saudi Arabia : Packing Scene

<Steam / Gas Silencer–, 6 Sets>



MAJOR REFERENCE LIST(PHOTO SCENE)

14. SC1692, SAMCo Acrylic Acid Project Jubail, Kingdom of Saudi Arabia :

Packing Scene <Steam Silencer – 4 Sets>



MAJOR REFERENCE LIST(PHOTO SCENE)

15. SECL, Sabic Gas Jubail Phase VIII Project, Jubail, Kingdom of Saudi Arabia :
Packing Scene <Gas / Air /CO2 Silencer – 20 Sets>



MAJOR REFERENCE LIST(PHOTO SCENE)

16. SECL, Fertil 2 Ammonia / Urea Expansion Project, Abu Dhabi, U.A.E.

Packing Scene<Steam / Gas Silencer – 3 Sets>



MAJOR REFERENCE LIST(PHOTO SCENE)

17. Thai National Power2 SPP Power Project, Thailand

Packing Scene <Steam Silencer – 2 Sets>



18. Tongsoh Petrochemical Corp., TS-7000 Project, Ulsan, Korea

Packing Scene <Steam Silencer – 1 Set>



MAJOR REFERENCE LIST(PHOTO SCENE)

19. KSA, Yanbu 2 Power and Water Project, Kingdom of Saudi Arabia
Packing Scene <Steam Silencer – 9 Sets>



MAJOR REFERENCE LIST(PHOTO SCENE)

20. Aramco, Wasit Gas Plant Co-Generation & Steam Generation Project, Kingdom of Saudi Arabia. Packing Scene <Steam Silencer – 39 Sets>



MAJOR REFERENCE LIST(PHOTO SCENE)

21. Sam Cheok Green power Plant Unit 1&2, Korea. Packing Scene
<Steam Silencer 140Ton/Hr, 59Ton/Hr – 12 Sets>



MAJOR REFERENCE LIST(PHOTO SCENE)

22. Umm Wu'al EPC Project – Ammonia Plant, Kingdom of Saudi Arabia.
Packing Scene <Steam/Air/Gas Silencer – 11 Sets>



MAJOR REFERENCE LIST(PHOTO SCENE)

23. SECL/Aramco, Luberef Yanbu Refinery Expansion Project,
Kingdom of Saudi Arabia. <Steam/Air/Gas Silencer – 99 Sets>



24. BHI/Calpine, York 2 Project – HRSG, USA
Packing Scene <Steam Silencer – 10 Sets>



MAJOR REFERENCE LIST(PHOTO SCENE)

25. Samsung C&T, Umm Al Houl Power IWPP, Qatar
<Steam Silencer – 4 Sets>



MAJOR REFERENCE LIST(PHOTO SCENE)

26. Daelim Ind., Thaibinh II Thermal Power Plant, Vietnam
Packing Scene <Steam Silencer – 7 Sets>



MAJOR REFERENCE LIST- STACK SILENCER(PHOTO SCENE)

1. TPPI, Turban Aromatic Project – HRSG, Indonesia

Packing scene<Splitters for By-pass Stack Silencer– 3 Sets>



2. Paju Combined Heat & Power Plant, Paju, Korea

Packing Scene <Splitters for Main Stack Silencer –2 Sets>



MAJOR REFERENCE LIST- STACK SILENCER(PHOTO SCENE)

3. Goyang/Samsung Combined Heat & Power Plant, Goyang, Korea
Packing Scene <Splitters for Main Stack Silencer – 2 Sets>



4. Busan JeungKwan Co-Gen. Project (2'nd), Busan, Korea
Packing Scene <Splitters for Main Stack Silencer – 1 Set>



MAJOR REFERENCE LIST- STACK SILENCER(PHOTO SCENE)

5. KIMANIS 300MW CCPP, Malaysia

Packing Scene <Splitters for By-pass Stack Silencer – 3 Sets>



MAJOR REFERENCE LIST- STACK SILENCER(PHOTO SCENE)

6. BUGOK III Combined Cycle Power Plant – HRSG, Dangjin, Korea
Packing Scene <Splitters for Main Stack Silencer – 1 Set>



MAJOR REFERENCE LIST- STACK SILENCER(PHOTO SCENE)

7.Andong Combined Cycle Power Plant – HRSG, Andong, Korea

Packing Scene <Splitters for Main Stack Silencer –ID7000x5680H – 1 Set>



MAJOR REFERENCE LIST- STACK SILENCER(PHOTO SCENE)

8. UGCC U&O Project, Ustyurt, Uzbekistan. Packing Scene

<Splitters for By-pass Stack Silencer – 3300Wx3300Lx4155H –3Sets>



MAJOR REFERENCE LIST- STACK SILENCER(PHOTO SCENE)

9. Ulsan #4 Combined Cycle Power Plant – HRSG, Ulsan, Korea

Packing Scene <Splitters for Main Stack Silencer – ID6652x1590H –2Sets>



10. The 2nd PyeongTaek CCPP–HRSG, PyeongTaek, Korea

Packing Scene <Splitters for Main Stack Silencer – ID6652x1590H –2Sets>



MAJOR REFERENCE LIST- STACK SILENCER(PHOTO SCENE)

11. Biskra 456.890 MW Gas Turbine Plant, Biskra, Algeria

Packing Scene <Splitters for By-pass Stack Silencer – ID9000x5415H –2Sets>



MAJOR REFERENCE LIST- STACK SILENCER(PHOTO SCENE)

12. OSAN Combined Heat & Power Plant, Osan, Korea

Packing Scene <Splitters for Main Stack Silencer – ID6742x3775H –1Sets>





Major Reference List (Sound Enclosure Part)

MAJOR REFERENCE LIST- SOUND ENCLOSURE(PHOTO SCENE)

1. GUNSAN CCPP (700MWx1) – BFP, Gunsan, Korea : Pre-assembling Scene
<Sound Enclosure – 2850W x 1600H x 3000L – 4 Sets>



2. CEBU Power Plant Project – BFP, Cebu, Philippines : Pre-assembling Scene
<Sound Enclosure – 3140W x 1700H x 2800L – 4 Sets>



MAJOR REFERENCE LIST- SOUND ENCLOSURE(PHOTO SCENE)

3. MARAFIQ STG Unit 5&6 Project – BFP, KSA, YANBU , KSA : Pre-assembling Scene
<Sound Enclosure – 6005W x 2850H x 3695L – 2 Sets>



4. IEC,Add-on Combined Cycle Units (Eshkol Unit4, Hagit Unit9, Ramat Unit9) – BFP, Israel :Assembly work Scene <Sound Enclosure – 4280W x 3000H x 6350L – 6 Sets>



MAJOR REFERENCE LIST- SOUND ENCLOSURE(PHOTO SCENE)

5. TUFANBEYLI TPP – BFP, Tufanbeyli, Turkey : Pre-assembling Scene
<Sound Enclosure – 3500W x 2450H x 3840L – 9 Sets>



6. PRAI CCGT POWER– BFP, Penang, Malaysia : Assembly work Scene
<Sound Enclosure – 3500W x 2450H x 4140L – 6 Sets >



MAJOR REFERENCE LIST- SOUND ENCLOSURE(PHOTO SCENE)

7. POCHEON CCPP IPP (UNIT #1) – BFP, Pocheon, Korea : Pre-assembling Scene
<Sound Enclosure – 4000W x 3000H x 5500L – 4 Sets>



. NAAMA CMBINED CYCLE POWER PLANT – BFP, Naama, Algeria : Pre-assembling
Scene <Sound Enclosure – 3680W x 2667H x 3197L – 8 Sets>



EXPERIENCE LIST(SOUND ENCLOSURE)

Date : Mar, 27, 2018

No.	PROJECT NAME	EQUIPMENT	CUSTOMER	CLIENT/EMPLOYER	Q'TY	LOCATION	YEAR
1	SOHAR POWER & DESALINATION PROJECT (IN THE SULTANATE OF OMAN) - BOILER FEED WATER PUMP	SOUND ENCLOSURE	HYOSUNG EBARA CO., LTD. / DOOSAN HEAVY INDUSTRIES & CONSTRUCTION CO., LTD.	SOHAR POWER COMPANY S.A.O.C	4	SOHAR, OMAN	2005
2	POSCO FINEX PROJECT - BOILER FEED WATER PUMP	SOUND ENCLOSURE	HYOSUNG EBARA CO., LTD.	POSCO	2	PO-HANG, KOREA	2006
3	INCHEON CCGP UNIT 2 - BOILER FEED WATER PUMP	SOUND ENCLOSURE	HYOSUNG EBARA CO., LTD. / SIEMENS AG.	KOREA MIDLAND POWER CO., LTD. (KOMIPO)	3	IN-CHEON, KOREA	2008
4	JEBEL ALI POWER AND DESALINATION STATION "M" -BOILER FEED WATER PUMP	SOUND ENCLOSURE	HYOSUNG EBARA CO., LTD. / DOOSAN HEAVY INDUSTRIES & CONSTRUCTION CO., LTD.	DUBAI ELECTRICITY & WATER AUTHORITY	12	JEBEL ALI, UAE	2008
5	QATALUM COMBINED CYCLE POWER PLANT - BOILER FEED WATER PUMP	SOUND ENCLOSURE	HYOSUNG EBARA CO., LTD. / DOOSAN HEAVY INDUSTRIES & CONSTRUCTION CO., LTD.	QATALUM	8	MESAIEED INDUSTRIAL AREA, QATAR	2009
6	GUNSAN COMBINED CYCLE POWER PLANT (700MWx1) - BOILER FEED WATER PUMP	SOUND ENCLOSURE	HYOSUNG EBARA CO., LTD. / S&T CORPORATION.	KOREA WESTERN POWER CO., LTD. (KOWEPO)	2	GUN-SAN, KOREA	2009
7	CEBU POWER PLANT - BOILER FEED WATER PUMP	SOUND ENCLOSURE	HYOSUNG EBARA CO., LTD. / DOOSAN HEAVY INDUSTRIES & CONSTRUCTION CO., LTD.	KEPCO SPC POWER CORPORATION.	4	CEBU, PHILIPPINE	2009
8	POWER SERAYA COGEN CCP 30&40 - BOILER FEED WATER PUMP	SOUND ENCLOSURE	HYOSUNG EBARA CO., LTD. / SIEMENS PTE LTD.	POWER SERAYA LTD.	4	SERAYA, SINGAPORE	2010
9	POWER SERAYA COGEN CCP 30&40 - DEAERATOR PUMP	SOUND ENCLOSURE	HYOSUNG EBARA CO., LTD. / SIEMENS PTE LTD.	POWER SERAYA LTD.	2	SERAYA, SINGAPORE	2010
10	SHUWEIHAT S2 INDEPENDENT WATER AND POWER PLANT -BOILER FEED WATER PUMP	SOUND ENCLOSURE	HYOSUNG EBARA CO., LTD. / SAMSUNG C&T / SIEMENS	RUWAIS POWER COMPANY	2	JEBEL DHANA, UAE	2010
11	MARAFIQ STG UNIT 5&6 PROJECT -BOILER FEED WATER PUMP	SOUND ENCLOSURE	HYOSUNG GOODSPRINGS, INC. / HANWHA ENGINEERING & CONSTRUCTION	POWER & WATER UTILITY COMPANY FOR JUBAIL & YANBU	2	YANBU, SAUDI ARABIA	2011
12	CFE NORTE 2 CCGT PROJECT - BOILER FEED WATER PUMP	SOUND ENCLOSURE	HYOSUNG GOODSPRINGS, INC. / KST ELECTRIC POWER COMPANY	CFE (COMISION FEDERAL DE ELECTRICIDAD)	4	CHIHUAHUA, MAXICO	2012
13	IEC ADD PROJECT - BOILER FEED WATER PUMP	SOUND ENCLOSURE	HYOSUNG GOODSPRINGS, INC. / DOOSAN HEAVY INDUSTRIES & CONSTRUCTION CO., LTD.	THE ISRAEL ELECTRIC CO., LTD.	6	ISRAEL	2012

EXPERIENCE LIST(SOUND ENCLOSURE)

Date : Mar, 27, 2018

No.	PROJECT NAME	EQUIPMENT	CUSTOMER	CLIENT/EMPLOYER	Q'TY	LOCATION	YEAR
14	GIMCHEON COMMUNITY ENERGY PROJECT - BOILER FEED WATER PUMP	SOUND ENCLOSURE	HYOSUNG GOODSPRINGS, INC.	GIMCHEON ENERGY CO., LTD.(KOLONG GROVAL / SK E&S)	2	GIMCHEON, KOREA	2012
15	TUFANBEYLI THERMAL POWER PLANT PROJECT - BOILER FEED WATER PUMP	SOUND ENCLOSURE	HYOSUNG GOODSPRINGS, INC. / SK ENGINEERING & CONSTRUCTION	ENERJISA	9	TUFANBEYLI, TURKEY	2013
16	PRAI CCGT POWER PLANT - BOILER FEED WATER PUMP	SOUND ENCLOSURE	HYOSUNG GOODSPRINGS, INC. / SAMSUNG C&T	TNB PRAI SDN. BHD.	6	PENANG, MALAYSIA	2014
17	OSAN COMBINED HEAT & POWER PLANT -BOILER FEED WATER PUMP	SOUND ENCLOSURE	HYOSUNG GOODSPRINGS, INC. / KEPCO E & C	DSPower	2	OSAN, KOREA	2015
18	POCHEON GAS COMBINED CYCLE POWER PLANT #1 - HP/IP FEED WATER PUMP	SOUND ENCLOSURE	HYOSUNG GOODSPRINGS, INC. / DAEWOO E & C	DAEWOO ENERGY	4	POCHEON, KOREA	2015
19	KIRIKKALE INDEPENDENT POWER PROJECT - BOILER FEED WATER PUMP	SOUND ENCLOSURE	HYOSUNG GOODSPRINGS, INC. / SAMSUNG C&T	ACWA GUC ELEKTROK ISLETME VE YONETIM SANAY VE TICARET A.S.	3	KIRIKKALE, TURKEY	2016
20	BISKRA COMBINED CYCLE POWER PLANT - BOILER FEED WATER PUMP	SOUND ENCLOSURE	HYOSUNG GOOD SPRINGS, INC. / HYUNDAI HEAVY INDUSTRIES & CONSTRUCTION CO., LTD.	SONELGAZ ELECTRICITY PRODUCTION COMPANY(SPE)	8	BISKRA, ALGERIA	2016
21	JJEL COMBINED CYCLE POWER PLANT - BOILER FEED WATER PUMP	SOUND ENCLOSURE	HYOSUNG GOOD SPRINGS, INC. / HYUNDAI HEAVY INDUSTRIES & CONSTRUCTION CO., LTD.	SONELGAZ ELECTRICITY PRODUCTION COMPANY(SPE)	8	JJEL, ALGERIA	2016
22	CHUNCHEON COMBINED HEAT & POWER PLANT - BOILER FEED WATER PUMP	SOUND ENCLOSURE	HYOSUNG GOODSPRINGS, INC. / KEPCO E & C	CHUNCHEON ENERGY CO., LTD.	2	CHUNCHEON, KOREA	2016
23	NAAMA COMBINED CYCLE POWER PLANT - BOILER FEED WATER PUMP	SOUND ENCLOSURE	HYOSUNG GOOD SPRINGS, INC. / SAMSUNG C&T CORPORATION	SONELGAZ ELECTRICITY PRODUCTION COMPANY(SPE)	8	MAAMA, ALGERIA	2016
24	LORDEGAN UREA FERTILIZER PLANT PROJECT	SOUND ENCLOSURE	HYOSUNG GOOD SPRINGS, INC. / HAMPA ENERGY ENGINEERING & DESIGN COMPANY	LORDEGAN UREA FERTILIZER COMPANY	2	LORDEGAN, IRAN	2017
25	MOSTAGHANEM COMBINED CYCLE POWER PLANT - BOILER FEED WATER PUMP	SOUND ENCLOSURE	HYOSUNG GOOD SPRINGS, INC. / SAMSUNG C&T CORPORATION	SONELGAZ ELECTRICITY PRODUCTION COMPANY(SPE)	8	MOSTAGHANEM, ALGERIA	2017
26	ALBA LINE 6 EXPANSION POWER STATION 5	SOUND ENCLOSURE	HYOSUNG GOOD SPRINGS, INC. / GAMA POWER SYSTEMS INC.	ALUMINIUM BAHRAIN B.S.C.	6	ASKAR, KINGDOM OF BAHRAIN	2018



11. SHOP HSE PLAN

DOC. NO. : JS-HSE-1205	SHOP HSE PLAN	DATE: May 10, 2012
REV. NO. : A		PAGE : 1 / 32

I N D E X

1. INTRODUCTION
2. OBJECTIVE
3. DEFINITIONS AND ABBREVIATIONS
4. COMMITMENT
5. HSE POLICY
 - 5.1. Design and Engineering HSE Policy
 - 5.2. Fabrication HSE Policy
6. HSE ORGANIZATION AND RESPONSIBILITIES
 - 6.1. Design Safety Organization
 - 6.2. Shop HSE Organization
 - 6.3. Roles and Responsibilities
7. HSE MEETING AND COMMUNICATIONS
 - 7.1. Communications Mediums
 - 7.2. HSE Meeting
8. HSE TRAINING
 - 8.1. HSE Induction Training for New Entrants
9. HSE INSPECTION AND AUDIT
 - 9.1. HSE Inspection in Site
 - 9.2. Finding and Monitoring of Unsafe Acts and Conditions
10. RISK ASSESSMENT AND WORK EXECUTION PROCEDURES
 - 10.1. Identification of Hazards and Risk Assessment
 - 10.2. Work Execution Procedure
11. PRACTICAL SAFETY PROCEDURES
12. EMERGENCY RESPONSE PLAN
13. PERSONNEL PROTECTIVE EQUIPMENT (PPE)

DOC. NO. : JS-HSE-1205	SHOP HSE PLAN	DATE: May 10, 2012
REV. NO. : A		PAGE : 2 / 32

- 13.1. Eye protection
- 13.2. Hand protection
- 13.3. Head protection
- 13.4. Foot Protection
- 13.5. Protection against noise

14 FIRE PREVENTION AND PROTECTION

- 14.1. General
- 14.2. Hot Work
- 14.3. Fire Extinguishers

15. HEALTH MANAGEMENT PLAN

- 15.1. Responsibilities
- 15.2. Health Risk Control
- 15.3. Health Hazards
- 15.4. General Health Promotion
- 15.5. Audit of Health Management

16. ENVIRONMENTAL MANAGEMENT

- 16.1. Environmental Management System (EMS)

17. SECURITY CONTROL PLAN

- 17.1. Security Procedure
- 17.2. Entry Control

18. ACCIDENT/INCIDENT INVESTIGATION AND REPORTING

- 18.1. Accident / Incident Investigation
- 18.2. Extent of Accident Investigation
- 18.3. Investigation Procedure
- 18.4. Accident Report
- 18.5. Follow-up Actions

19. HSE REPORT

- 19.1. Weekly HSE Report
- 19.2. Monthly HSE Report

20. HSE PROMOTION

21. HSE MANAGEMENT REVIEW

DOC. NO. : JS-HSE-1205	SHOP HSE PLAN	DATE: May 10, 2012
REV. NO. : A		PAGE : 3 / 32

22. WORK SHOP DOCUMENTATION

ATTACHMENT

Attachment 1 HSE Activities Programs



12. DETAILS OF SUB-SUPPLIERS LIST

Sub-suppliers list

Sub-Vendor	Address	Tel. / Fax.	Remark
1. STEELPLATE			
POSCO	1, Goedong-dong, Nam-gu, Pohang-si, Gyeongsangbuk-do, Korea	TEL : 82-54-160-0014 FAX : 82-54-160-6000	
DONGKUKSTEEL	Union Steel Building 412 Teheranlo, Kangnamgu, Seoul, Korea	TEL : 82-2-317-1114 FAX : 82-2-317-1391	
HYUNDAI STEEL	167-32, Goderi, Songakup, Dangjinsi, Chungcheongnam-do, Korea	TEL : 041-680-0114 FAX : 041-680-1199	
ILSENBURGER GROBBLECH	Veckenstedter Weg 10 D-38871 Ilsenburg, Germany	TEL : 49 (0) 39452 85-0 FAX : 49 (0) 39452 85-8161	
KOBE STEEL	1, Kanazawa-cho, Kakogawa-city, Japan	TEL : 81-79-436-1111 FAX : 81-79-436-1400	
2. STAINLESSSTEELPLATE			
POSCO	1, Goedong-dong, Nam-gu, Pohang-si, Gyeongsangbuk-do, Korea	TEL : 82-54-160-0014 FAX : 82-54-160-6000	
KUNSHAN D.K.C	150-743, KT B/D 16F, Yoido-dong, Youngdeungpo-Gu, Seoul, Korea	TEL : 82-2-3016-2864 FAX : -	
OUTOKUMPU	Post Box 74, S-774 16Avesta, Sweden	TEL : 46-166 813-57 FAX : 46-166 813-16	
APERAM	Swinnenwijerweg 5, Poon Genk 7523 3600 Genk, Belgium.	TEL : 30(0)89-30-21-11 FAX :	
3. STEELPIPE			
NIPPON STEEL & SUMITOMO METAL	1-15, Kitanama, Higasi-ku, Tokyo, Japan	TEL : 81-3-3282-6316 FAX : -	
VALLOUREC & MANNESMANN	27 avenue du General Leclerc 92660 Boulogne Billancourt Cedex France	TEL : 33-1-49-09-36 -79 FAX : -	
TENARIS	Dalmine S.p.A. Piazza Caduti 6 Luglio 1944, 1 24044 Dalmine (Bergamo) Italia	TEL : 39-035-560-111 FAX : -	
BENTELER	Postfach 13 40 33043 Paderborn, Germany	TEL : 49-5204-81-0 FAX : -	
JFE STEEL	1, Kawasaki-cho, 1-Chome, Haneda 475, Japan	TEL : 81-86-447-2020 FAX : -	
SIN-E B&P	1900, Seohae-ro, Cheongbuk-Myeon Pyeongtacek-Si, Gyeonggi-Do, Korea	TEL : 82-31-615-3674 FAX : 82-31-615-3688	

Sub-Vendor	Address	Tel. / Fax.	Remark
4. FLANGE			
KOFCO	194, Dongbu-dong, Dong-gu, Ulsan, Korea	TEL : 82-52-233-5511 FAX : 82-52-233-5507	
HYUNDAE FITTING CO., LTD	1202-5, Jisa-dong, Kangseo-gu, Busan, Korea	TEL : 82-51-831-0891 FAX : 82-51-831-0896	
MYUNGSUNG S&T CO., LTD.	1622-6, Songjung-dong, Gangseo-gu, Busan, Korea	TEL : 82-51-302-6162 FAX : 82-51-302-6160	
SAM YOUNG FLANGE CO., LTD.	596-12, Hwajeon-dong, Gangseo-gu, Busan, Korea	TEL : +82-51-911-3000 FAX : +82-51-911-3001	
KOREA METAL	587-5, Hwajeon-Dong, Gangseo-Gu, Busan, Korea	TEL : 82-51-831-7354 FAX : 82-51-831-7356	
WON PLANT	229, Daedong-ro, Sasang-gu, Busan, Korea	TEL : 82-51-322-3446 FAX : 82-51-322-3447	
N.H METAL	#246-10, Hak-Jang Dong, Sasang-Gu, Busan, Korea	TEL : 82-51-311-4080 FAX : 82-51-311-4082	
5. FITTING			
SUNGKWANG BEND	1720, Songjung-Dong, Gangseo-gu, Busan, Korea	TEL : 82-51-330-0200 FAX : 82-51-330-0330	
TAEKWANG	117-12, Noksansaneop-daero, Gangseo-gu, Busan, Korea	TEL : 82-51-970-6600 FAX : 82-51-831-6969	
SBC BEND	178, Wolchongongdan-ro, Gunbuk-Myeon, Haman-gun, Gyeongsangnam-do, Korea	TEL : 82-55-580-9900 FAX : -	
6. ACOUSTIC MATERIAL			
KCC	510-43, Seobu-dong, Dong-gu, Ulsan, Korea	TEL : 82-52-267-0812 FAX : 82-52-267-0865	
BYUCKSAN	GwanghuiBldg, 216 Gwanghui-dong 1-ga, Jung-gu, Seoul, Korea	TEL : 82-2-1660-6075 FAX : 82-2-1675-0550	
7. BOLT/NUT			
KPF	731-3, Wonsi-dong, Danwon-gu, Ansan-si, Gyeonggi-do, Korea	TEL : 82-31-491-3081 FAX : 82-31-492-7034	
SINJIN BOLT	004-36, Namsan-dong, Chanwon-si, Gyeongsangnam-do, Korea	TEL : 82-55-297-9531 FAX : 82-55-297-9530	
DAE DO BOLT	156-3, Mujine-dong, Siheung-si, Gyeonggi-do, Korea	TEL : 82-31-316-1116 FAX : 82-31-316-1118	
SAMSUNG METAL	1142-2 Yochondong NamGu Ulsan Korea	TEL : 82-52-275-0758 FAX : 82-52-271-7079	

Details of sub-suppliers

Sub-Vendor	Address	Tel. / Fax.	Remark
1.ROLLING, BENDING, CUTTING			
KUKMIN BENDING	2095-4, Jungwang-dong, Siheung-shi Gyeonggi-do, Korea	TEL : 82-31-497-5441 FAX : 82-31-497-5771	
BAIKYANG CMP	1372, Jungwang-dong, Siheung-shi Gyeonggi-do, Korea	TEL : 82-31-497-5400 FAX : 82-31-497-5403	
2. PUNCHING			
SEONGSIL ENG	1263-3, Jungwang-dong, Siheung-shi Gyeonggi-do, Korea	TEL : 82-31-498-6961 FAX : 82-31-498-6964	
3. FORMING			
SEAJIN ENG	1364, Jungwang-dong, Siheung-shi Gyeonggi-do, Korea	TEL : 82-31-430-2051 FAX : 82-31-430-2052	
4. SURFACE PREPARATION & PAINTING			
DOOSUNG	2100-2, Jungwang-dong, Siheung-shi Gyeonggi-do, Korea	TEL : 82-31-432-3277 FAX : 82-31-432-3288	
5. NDE, PMI			
ENERGY TECH	627-6,Yaelim-RiJungkwan-myeon, Kijang-gun, Busan, Korea	TEL : 82-31-498-8941 FAX : 82-31-432-5999	
ARGUS	106-2, Imae-dong, Bundang-gu, Seongnam-si, Gyeonggi-do, Korea	TEL : 82-31-715-5577 FAX : 82-31-716-1144	
SITCO	7-42,Yangjin B/D,Yangjae-dong Seocho-gu, Korea	TEL : 82-2-552-1112 FAX : 82-2-553-1629	
6. HEAT TREATMENT			
DAEHYEUNG HEAT TREATMENT	720-3,4 Gojan-dong Namdong-gu, Incheon-si, Korea	TEL : 82-32-814-3104 FAX : 82-32-816-7497	
7. EXPORT PACKING			
SUNWOONG EXPORT PACKING	687-1, Sunggok-dong, Ansan-si, Gyeonggi-do, Korea	TEL : 82-31-498-4047 FAX : 82-31-498-7802	



13. COMPANY QUALITY MANAGEMENT SYSTEM MANUAL

QUALITY MANUAL

DOCUMENT NUMBER : JSQM-9001

CONTROLLED COPY

UNCONTROLLED COPY

Rev. No	Description	Prepared	Reviewed	Approved
3	Title	Quality Assurance Team	Quality Management Representative	CEO
	Name	M.S.LEE	J.J.KIM	S.J.LIM
	Signature			
	Date	May 08, 2014	May 08, 2014	May 08, 2014



JS TECHNOS CO., LTD.

57, Mayu-ro 70 beon-gil, Siheung-si, Gyeonggi-do,
(709-1, 3 Ma, Sihwa Industrial Complex, Jeongwang-dong)

TEL : 031-431-4330 / FAX : 031-431-6266

No. JSQM-9001	I . Table of Contents and Revision History	Date 05.08,2014
Rev. 3		Page 1 / 2

Index and Revision Status			
Chapter	Title	Number of page	Rev. No.
I	Index and Revision Status	2	3
II	Company Introduction	1	3
III-1	Overview of Quality Management Manual	1	1
III-2	Quality Policy	1	1
III-3	Management of Quality Manual	2	1
IV-1	System-related procedures	2	1
IV-2	Scope of Application	1	1
IV-3	Definition of Terms	1	1
V	Quality Management System	-	-
V-1	General Requirements	3	1
V-2	Documentation Requirements	4	1
VI	Management Responsibility	-	-
VI-1	Management Commitment	2	1
VI-2	Customer Focus	1	1
VI-3	Quality Policy	1	1
VI-4	Planning	2	1
VI-5	Responsibility, Authority and Communication	2	1
VI-6	Management Review	3	1
VII	Resource Management	-	-
VII-1	Provision of resources and Human resources	2	1
VII-2	Infrastructure and Business environment	2	1
VIII	Product Realization	-	-
VIII-1	Planning of Product Realization	2	1
VIII-2	Customer-related Processes	2	1
VIII-3	Design	2	1
VIII-4	Purchasing	2	1
VIII-5	Production and Service provision	3	1
VIII-6	Monitoring and Management of Measurement	1	1
IX	Measurement, Analysis and Improvement	-	-
IX -1	Monitoring and Measurement	2	1
IX -2	Control of Nonconforming Product	2	1
IX -3	Analysis of Data	1	1
IX -4	Improvement	2	1

No. JSQM-9001	I . Index and Revision Status	Date 05.08,2014
Rev. 3		Page 2 / 2

Revision history			
Rev. No.	Date of revision	amendment content	Remarks
0	Aug. 06, 2007	First enactment	
1	Feb. 06, 2009	Revised by the change KS Q ISO 9001:2008	
2	Jun. 28, 2013	Revised by the relocation of Head office of the company and the variation of company status	
3	May 08, 2014	Revised by the relocation of Head office of the company and the variation of company status	

No. JSQM-9001	II. Company Introduction	Date 05.08,2014
Rev. 3		Page 1 / 1

1. Company Overview

JS Technos Co. Ltd. (hereinafter "The company") was established on March 3, 2001 as the special manufacturer of Noise and vibration control facilities, Silencers, Sound enclosures, Vessels, Tanks and Pipe supports. The company will comply with and executing Quality Manual for the highest quality. The company wish to grow to the best company in the industrial field and contribute to the social contributions.

2. Company current situation

Company Name	JS Technos Co. Ltd.	CEO	Sook Ja, Lim
Location : Head Office & Factory	57, Mayu-ro 70 beon-gil, Siheung-si, Gyeonggi-do, (709-1, 3 Ma, Sihwa Industrial Complex, Jeongwang-dong)	Tel.	+82-31-431-4330
		Fax.	+82-31-431-6266
		E-mail	sales@jstechnos.com
Main Products	Noise and vibration control facilities, Silencer, Sound enclosure, Vessel, Tanks, Pipe support	Date of establish	March 3, 2001
Capital	2 Million USD	Production capacity	5.5 Million USD
Business Registration Number	113-81-67913	Kind of Registration	Manufacture and Service
Plant Scale	Area	1655 m ²	
	Building	1324 m ²	
	Power	420 KW	

No. JSQM-9001	III-1. Overview of Quality Manual	Date 02.06,2009
Rev. 1		Page 1 / 1

1. Scope of Application

1.1 General details

This Quality Manual is applicable to all processes related to the Company's Quality Management System. Also this Quality Manual includes the systems for the continuous improvement and nonconforming prevention so that the company makes sure to provide the conforming products to meet the customer's requirements as well as to achieve the customer's satisfaction.

1.2 Application

This Quality Manual is applicable to all of the restriction requirements of KS Q ISO 9001:2009 / ISO 9001:2008.

2. Purpose

The purpose of this manual is to use as the instructions for the evaluation that the capability of the internal and external stakeholders of the organization meets to the customer requirements, regulatory requirements, and the organization itself.

3. Definition

This manual describes the sequence and interaction of these processes included in the Quality Management System for the quality policy to be observed and well-documentation for the basic requirements related to the quality in order to execute, maintain and improve the Quality Management Activity efficiently.

4. Composition

This manual is composed to the regulatory requirements of each item in Quality management system including the measurement, the analysis and the improvement in accordance with KS Q ISO 9001:2009 / ISO 9001:2008. The company has to set the customer's requirements clearly and properly and convert to be able to apply any process related to quality management system. Also this manual is composed to be able to execute the achievement of the customer's satisfaction certainly.

No. JSQM-9001	III-2. Quality Policy	Date 02.06,2009
Rev. 1		Page 1 / 1

The company enacts Quality policy as follows to develop to the company corresponding with the expectations and the needs from the customer. And the company contributes to the social contribution through the reliability and the stability of quality.

Quality Policy

- Maximization of customer's satisfaction by Producing the highest quality products
- Cost reduction through Process improvement and Technology development
- Construction of The best quality management system through Continuous quality improvement

The officers and employees of the company understand the Quality policy to achieve Quality policy and execute the right task in accordance with Quality management system.

Aug. 06, 2007

C E O : Sook Ja, Lim

Sook Ja Lim

14. CATALOGS OF THE PRODUCTS

Industrial Silencer (JS-VS Type)

Purpose and Structure

When at a secondary side, High-pressure fluid released into the atmosphere from Safety valve, pressure regulating valves, relief valves, the velocity of fluid is changed to the speed of sound or more the speed of sound in the air. It is causing friction with the air and generating very loud noise. In addition, the high-frequency components are formed around a vent and the low-frequency components are formed at a little distance. These noises are forms to combine high-frequency components with the low-frequency components. So in order to reduce the noise frequency, analysis is required and it is most important to find the peak frequency. In accordance with the frequency analysis, our industrial silencers have a diffuser parts to change the high-frequency into the low-frequency and Expansion Chamber for low –frequency, Acoustic Modules for high-frequency components, Shell and Head. The company makes, designs and installs the industrial silencers which assemble above specified parts.

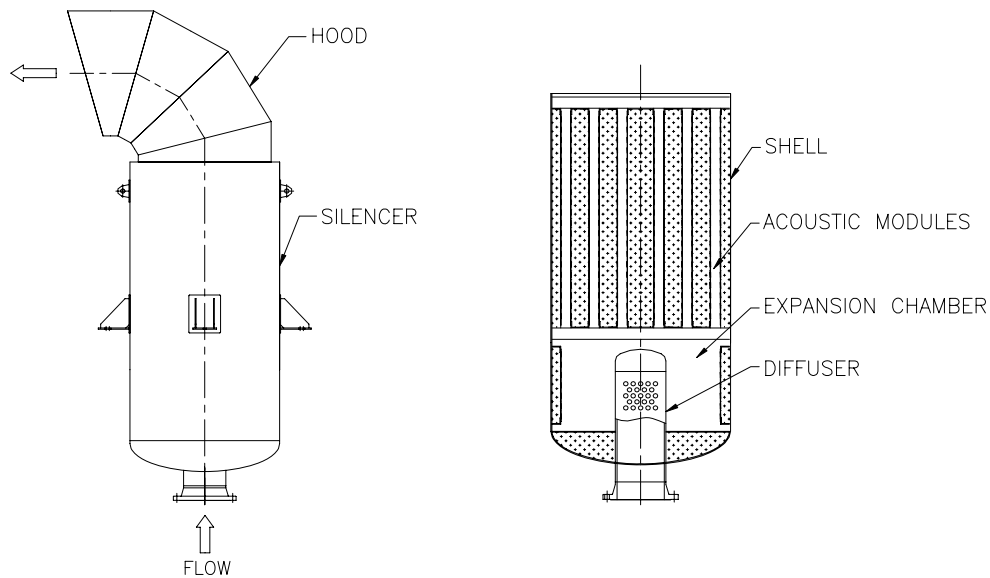

Order Specifications

This silencer designed and manufactured in accordance with order specification, so when ordering, please notify the following order specifications.

Type	Description	Order Specification				Remarks
JS-VS	Vent Silencer	Design Flow		Noise requirements		
		Design pressure		Connection Nozzle Size		
		Design temperature		Valve specifications		
		Allowable pressure loss		Flange specifications		
		Kind of fluid		Measure the distance		